

THE OEM GUIDE TO RECESSED DOWNLIGHTS

Covering all mechanical aspects,
requirements, and solutions

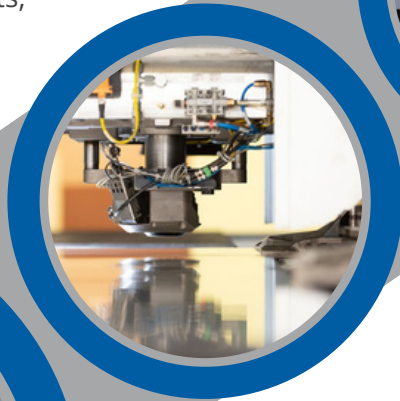
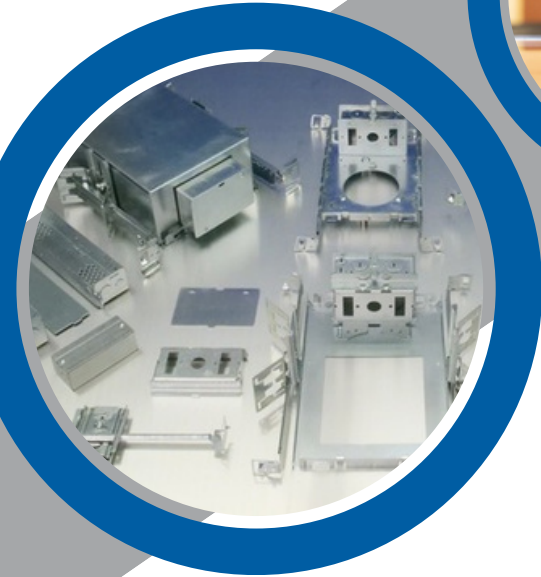

Please note

This OEM guide and all its content is copyrighted by
Tripar Inc. For OEMs and internal distribution.

Table of Contents

1. Message from the President	4
2. Quick Introduction	5
3. Metal fabrication processes & tooling	6
4. Materials	7
5. Principle downlight styles	8
6. Downlight assemblies: retrofit or remodeler	13
7. Downlight assemblies: New construction non-IC contact	21
8. Downlight assemblies: New construction insulated ceiling	41
9. Downlight suspension for new construction	53
10. Driver boxes	59
11. Final note	63
12. About Tripar	64
13. Free stuff	65



A message from the President

Dear reader,



Congrats on downloading your guide.

What you are holding is pure gold. Our guide has helped hundreds of OEMs launch their lighting products fast, cutting product development time in half while respecting the UL1598 requirements.

We're now on the 10th edition of *The OEM Guide to Recessed Downlights*. Since launching it in 2016, this guide has become a huge success. Every few years and with each new addition, we add more sections based on new products and the latest requirements.

Consider this a living breathing document; the only **OEM mechanical downlight guide** you need. It's backed by our 75+ years of experience in the lighting industry. What's more, our lighting components can be found in thousands of lighting fixtures and millions of buildings in North America.

Happy reading. May it serve you well.

Warmly,

A handwritten signature in black ink that reads "Lloyd S.".

Lloyd Sevak

"This is the bible of downlights. Studying this will drastically increase your knowledge of downlights. This company is located in Montreal." - an email from the CEO of a Top Lighting Company sent to his engineering team

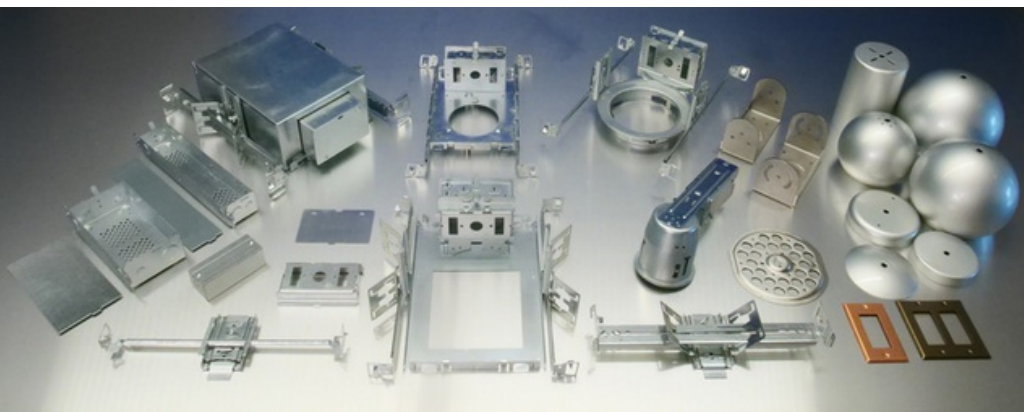

2. Quick Introduction

Tripair is the largest supplier of recessed lighting components in North America. We offer many products and solutions to meet your needs. This guide provides both generic information and UL1598 requirements for the downlight market, as well as Tripair specific solutions.

This guide describes the mechanical aspects of common recessed or downlights, and their requirements to produce Underwriters Laboratories (UL) listed luminaires for the North American market. UL is an American safety consulting and certification company that created UL1598¹, the principal specification governing luminaires setting the standards for the lighting industry. It is however important to note that companies other than UL can test to these standards such as Intertek, and Electrical Testing Laboratory (ETL).

Downlights are typically made up of a common core of mechanical components. Depending on the luminaire design, wiring, lumen output, and heat generated, these can all have an impact on the mechanical requirements imposed by UL. For this reason, individual mechanical components cannot be UL listed or certified. Tripair's product line however is designed to meet all the mechanical aspects imposed by UL1598. As such, this guide will refer to Tripair specific item numbers and provide links to them.

Where the text refers to a series of Tripair part numbers (e.g., "...1231-X series..."), this means that many variants of the same base part exist, the suffix of which defines the specific. For example, the 1231-12 plaster frame contains a 3-1/4" hole, the 1231-15 contains an 8-1/2" hole.

We welcome any feedback on this guide, whether they be suggestions, comments, or product suggestions. Contact us at lighting@TripairInc.com.

¹This Standard applies to luminaires for use in non-hazardous locations and that are intended for installation on branch circuits of 600 V nominal or less between conductors in accordance with the Canadian Electrical Code, Part I (CEC), CSA C22.1, with the U.S. National Electrical Code (NEC), ANSI/NFPA 70, and with the Mexican National Electrical Code, NOM-001-SEDE.

3. Metal Fabrication Processes & Tooling

Depending on the shape, sheet metal components can be made by one or more of the following processes, each with their pros and cons:

	Operations	Pros	Cons
Metal fabrication	CNC punched CNC laser cut Bending in a press break	1. Little to no tooling (dies)	1. Slower than stamping 2. More labor intensive 3. Higher cost
Metal stamping	Press punched Formed with one or more dies	1. High production rates 2. Fewer operations 3. Lower costs	1. Tooling (dies) req. 2. Cost a few thousand \$ for a simple die to tens of thousands for a complex die
Spinning	Three dimensional round parts formed by sheet, "wrapped" around spinning form	1. Lower tooling cost than stamping	1. More labor intensive than drawn parts 2. Parts must be round 3. Spinning can impart "spin" marks thus buffing costs increase if plating or painting required 4. Less dimensional control (accuracy) as compared with drawing
Drawing & deep drawing	Three dimensional parts formed by sheet, "drawn" over a solid form, using a die	1. Faster than spinning (less costly) 2. Can be any shape	1. Tooling (dies) req.

Tripair offers a combination of sheet metal processes:

- 1. Metal Fabrication:** CNC Punch/Laser combination machine, Laser, Punch & Press Breaks
- 2. Metal Stamping:** Progressive dies, drawing, and deep drawing
- 3. Hybrid manufacturing:** A combination of the above processes, the selection of which is dependent on part complexity and volumes.

Additionally, because we specialize in lighting and have been in business for 75 years, we have amassed over 1600 dies of all types, (of which several hundred are draw & deep draw dies), the vast majority of all are "open tooling", meaning Tripair owns and maintains these dies, ready for any OEM's use.

Using our products & processes can save you precious design time, lead time and tooling cost. Should you need something that is not shown, do not hesitate to ask. Tooling can often be modified at little or no tooling cost to produce variants of these items, or entirely new parts altogether.

With Tripair being the largest stamped & fabricated metal components supplier in the OEM lighting market, we stand ready to become your strategic stamped metal components supplier.

Check out our [metal stamping and deep drawing in action](#)

4. Materials

Above ceiling

Most above ceiling components need only have light protection from corrosion and be free from oils or other residues. For these reasons, most metal components are made from galvanized steel. There are instances where a non-reflective finish is desirable (e.g., painted black steel).

Examples include:

- Increased heat dissipation: Heat is absorbed more readily.
- Visual absorption: Inside of IC box becomes almost invisible - especially important for large and/or multi-lamp cutouts.

In very damp locations, or where non-magnetic properties are required (e.g., in MRI rooms), the same components can often be made in aluminum, though sometimes in thicker gauges to maintain strength. In the latter application (MRI rooms), springs can be made from a non-magnetic grade stainless steel, and any riveting done using aluminum or brass rivets.

Thickness is either determined based on each part's functional requirements, or to adhere to specific rules imposed by UL1598 or other legislation, e.g., min .05" for junction boxes made of steel.

Below ceiling

Most below ceiling components are made from cold rolled steel, followed by painting or plating. Prepainted and preplated steels can be used and are more cost effective than post-finishing, provided two edge related issues are recognized and acceptable.

- The edges remain in their "as-stamped" condition, thus can be sharp.
- Not being coated after being produced, the same edges will be bare (uncoated), though generally not a problem for indoor application.



5. Principle downlight styles

The following is an overview of the different principle downlight styles. Detail on each is provided in the sections following the Downlight Assemblies.

5.1 Retrofit or Remodeler

“Retrofit” or “Remodeler” are the terms used for assemblies which are designed to be installed from the room, through a hole made into an existing fixed ceiling. These typical contain a housing, usually round, but can be square or rectangular), with a junction box affixed to the top or side of the housing.

Part #	Description
1213-X	Junction box
1214	Cover
1210ZN-X	Housing
Z1652	Clips

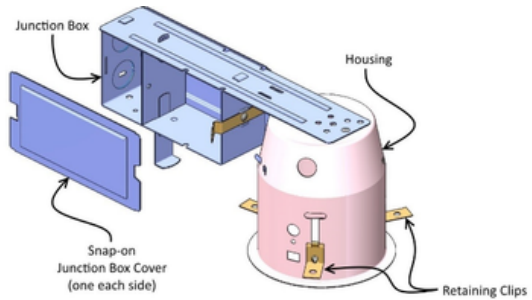

Fig. 1 Typical retrofit or remodeler assembly

This system may also be used for existing drop ceilings, in which ceiling panels are dropped onto T-bar. However, in such cases, the panels can easily be removed, and the downlight installed as would be for new construction.

It is important to note that within architectural, commercial, and higher end residential recessed lighting, new construction significantly outsells retrofit or remodeler. By its very definition or purpose, retrofit implies adding the fixture to an existing ceiling. This may make sense or be a requirement for lower end lighting. In higher end lighting however, even in renovation projects, the ceiling is often ripped down, not just to accommodate lighting, but also communication, HVAC, and other electrical upgrades, in which these installs become new construction.

5.2 New Construction

There are four principle applications and requirements;

- Non-IC (non-insulation contact)
- IC, Non-Airtight
- IC, Reduced Airflow
- IC, Ultra-Airtight

5.3 Non-IC

This style is permitted in ceilings where no insulation is in contact with the downlight, and no other municipal or state laws¹ imposes additional requirements. This typically consists of a steel tray commonly known as a plaster frame or tray, which rests on the same plane as what will become the top side of the ceiling, in which a hole through the plaster frame and ceiling permits the installation of the downlight. The hole size (and shape) is usually customized to suit the lighting OEMs luminaire size(s).

Part #	Description
1232-X	Junction box
1242	Cover (ext.)
1242-X	Cover (int.)
1231-X	Plaster frame
1287	Bar Hangers

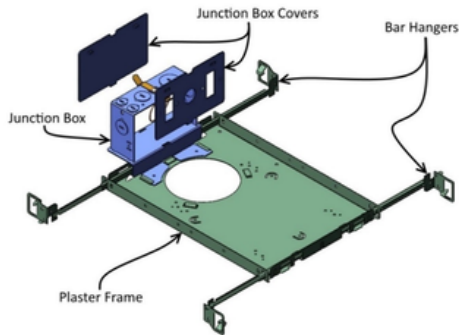

Fig. 2 Typical plaster frame assembly containing integral junction box & junction box covers

¹Though UL1598 is the principle specification governing luminaires, additional institutional, municipal, and/or state laws can impose further requirements, thus there is unfortunately no absolute national standard.

Alternately, a plaster frame containing an adjustable round or square hole may be employed. See [our catalogue of non-I.C. plaster frames](#).

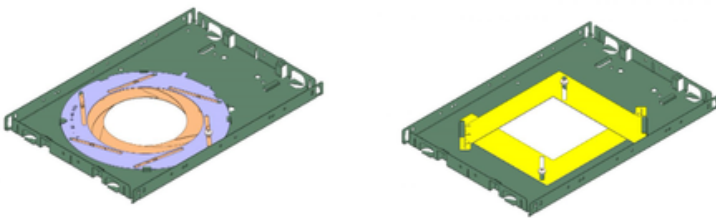

Fig. 3 The patented Shutter™; Adjustable hole plaster frames

Other common mechanical components in such an assembly include a junction box & junction box covers (for use as the wiring compartment), and bar hangers (used to suspend the assembly before the ceiling is installed). The plaster frame may also contain the ability to permit vertical adjust in order to raise it above the top side of the ceiling.

5.4 IC, Non-Airtight

When there is insulation in the ceiling, the top side of the luminaire (plaster frame assembly) must be enclosed by a metal barrier or enclosure, commonly known as an IC box. If there are no municipal or state laws¹ that imposed airflow restrictions, the enclosure need not be airtight.

Part #	Description
1233-1-10	Knockdown I.C. Box Part A
1233-2	Knockdown I.C. Box Part B
1232-X	Junction box
1242	Cover (External)
1242-X	Cover (Internal)
1231-X	Plaster Frame
1287	Bar Hangers

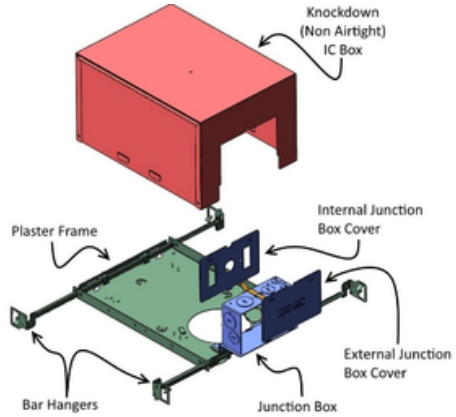

Fig. 4 Non-airtight IC Box placed behind plaster frame assembly containing integral junction box & junction box covers

¹Though UL1598 is the principle specification governing luminaires, additional institutional, municipal, and/or state laws can impose further requirements, thus there is unfortunately no absolute national standard.

5.5 IC, Reduced Airflow/Chicago plenum

When there is insulation in the ceiling, and municipal or state laws¹ impose heat retention or airflow restrictions, the luminaire must be enclosed by a metal barrier or enclosure (IC Box) that suitably reduces airflow.

Part #	Description
1685-11 (e.g.)	I.C. Box
1242-30	Cover (External)
1242-31	Cover (Internal)
1286-X	Plaster Frame
1287	Bar Hangers

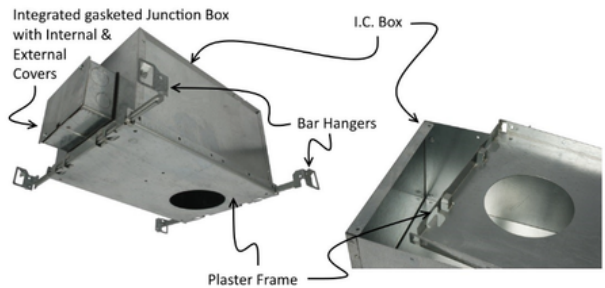

Fig. 5 Reduced Airflow IC Box placed behind plaster frame assembly containing integral junction box & junction box covers

¹Though UL1598 is the principle specification governing luminaires, additional institutional, municipal, and/or state laws can impose further requirements, thus there is unfortunately no absolute national standard. For example, the Construction Requirements for the City of Chicago Environmental Air Spaces (CCEA) impose requirements that the IC Box must have, amongst other requirements, no open holes, which is often referred to as the "Chicago Plenum Act" or "Chicago Plenum boxes".

5.6 What is Chicago plenum?

Both Tripar's Reduced Airflow & Ultra-airtight IC Boxes have been used as a basis to meet what is commonly referred to as "Chicago plenum"² rated luminaires.

Though there is no specific airflow metric in this specification, the mechanical aspects of this specification in part, require;

- Luminaire & wiring compartments to be sealed off and gasketed or otherwise have no openings.
- Unused screw openings shall be closed by use of metallic screws, rivets, sealant or equivalent.
- All seams or joints are to be tight and overlapping or shall be additionally gasketed or sealed.
- Junction boxes and covers shall have no holes, and all covers that open into the ceiling space shall be gasketed.
- All knockouts shall be of the "flush" or "press back" type.

²For complete requirements, consult the specification; Section 18-27-300.22(c) of the city of Chicago Electrical Code. Once the complete assembly has been tested & listed to the applicable specification, the Recessed Luminaire is eligible for the marking, "CCEA" (City of Chicago Environmental Air other than Ducts and Plenums).

5.7 What are Fire-Rated Recessed Downlights?

Not often, but lighting OEMs sometimes encounter a requirement to install fire-rated recessed downlights. Those that meet such a specification should have been successfully tested in accordance with UL263, Fire Tests of Building Construction and Materials, at which point may make claims such as;

- "...X hours of protection in L500,D500,G500,L200,D200,G200,J200 floor/ceiling designs, or,
- "Up to X hour in P500 and P200 roof/ceiling designs", or,
- "1 hour fire rate housing under L500 Wood Floor Assemblies".

Considering that we are very rarely asked for this, combined with the cost (\$18,000 for UL or a certified lab to build a small room mock-up, then burn it down for a one-time test), we never pursued this. Not only that, but if it this one-time test fails, we would have to make design changes, then resubmit and need to pay this fee again.

Recessed Fire-Rated Lighting Enclosures

Instead, what some of our customers do when required, is to suggest that their customer or the installer use a product on the market that is simply a fire-rated metal barrier, into which non-fire rated recessed lighting fixtures can be installed, allowing the complete assembly to classify with a fire rating; see <https://ezbarrier.com/ic-rated-light-enclosures/>.

Should the OEM still wish to design an enclosure that they feel would be fire rated, we can likely produce this, but testing would be the responsibility of the OEM.

5.8 IC, Ultra-Airtight (AT)

When there is insulation in the ceiling, and municipal or state laws¹ impose heat retention or specific airflow restrictions, (e.g. < 2 cfm under pressure (vacuum) of 1.57lbs/ft², ref. Florida Building Code Chapter 13 “Florida Energy Efficiency for Building Construction”, section 13-606.1.ABC.1.2.4 Recessed lighting fixtures), the luminaire must be enclosed by a metal barrier or enclosure (IC Box) that restricts airflow to the applicable specification(s).

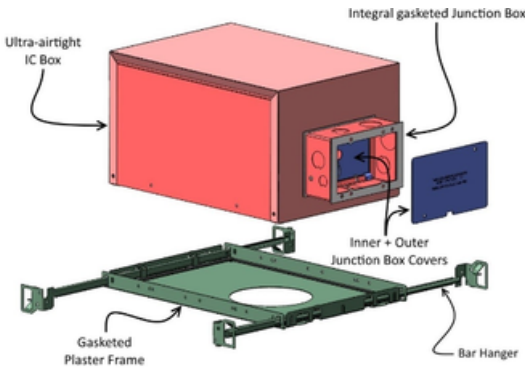

Part #	Description
1685-11 (e.g.)	I.C. Box
1242-30	Cover (External)
1242-31	Cover (Internal)
1286-X	Plaster Frame
1287	Bar Hangers

Fig. 6 Typical Ultra-airtight IC Box with integral gasketed junction box & gasketed plaster frame

¹Though UL1598 is the principle specification governing luminaires, additional institutional, municipal, and/or state laws can impose further requirements, thus there is unfortunately no absolute national standard.



Our new [Trapezoid IC Boxes](#) now meets the above noted airflow requirements without the need for gasketing, and offers many more advantages, see section 8.5.

6. Downlight Assemblies: Retrofit or Remodeler

Before any downlight installation takes place, an electrician must bring power (120 VAC line voltage) to each desired downlight location, where a hole sized for the eventual downlight is cut. This is often not an easy job, as wiring must be routed or fished through existing ceiling joists, or across joists by using armored cable passed through grooves under the joists and suitably protected.

Depending on the light source, heat generated, and whether or not the ceiling is insulated, a retrofit or remodeler often may require a round can or housing, though can be square or rectangular. A junction box that is attached to the housing via an arm that forms the top side of the junction box. The assembly is designed to be installed from the room, through a hole made into an existing fixed ceiling. The hole should be slightly larger than the housing diameter, as indicated in the OEMs instruction sheet.

Prior to installing the downlight into the ceiling, the previously routed line voltage must be connected to the downlight through the junction box. The junction box may then be passed through the hole, then rotated until the housing is vertical, permitting it to be fitted into the hole. The flange at the bottom of the housing covers the edge of the hole and prevents the housing from penetrating into the ceiling.



Fig. 7 Typical retrofit or remodeler assembly being rotated into hole in existing ceiling

It is important to note that in order for the junction box to fit into the hole, its diagonal distance across the corners (as viewed from the end) cannot be larger than the hole cut into the ceiling. This not only limits junction box size, but also driver size.

6.1 Housing

Housings vary in diameter from not much more than 2" for use with very small luminaires, e.g., MR11 or similar, to 5" or more for use with larger luminaires, e.g., PAR 38 or similar. Diameter requirements may not be driven solely by luminaire size (diameter), but also by tilt requirements if the luminaire has provision to pivot, where the diameter may need to be increased to accommodate the pivoting body of the luminaire within the housing.

Housing heights also vary, typically driven by the height of the luminaire.

Part #	Description
0687ZN-11	Housing, \varnothing 2 1/2"
R30POTZN-17	Housing, \varnothing 4 5/16"



Fig. 8 Typical housing

6.2 Junction box

The junction box is attached to the housing via an arm that often forms the top side of the junction box. Both sides of the junction box typically accept snap-on covers, permitting toolless installation and removal. As per UL1598, para. 11.3, both the junction box and cover must be at least .05" thick if made of steel, and .09" if made of aluminum.

If the luminaire is powered by line voltage, the junction box can have a single (wiring) compartment. If the luminaire is driven by low voltage, the junction box may contain a divider, allowing line voltage to be fed into the far side compartment, the transformer or driver placed in either compartment, creating a low voltage accessible compartment within the junction box. The driver is often affixed to one of the junction box covers; either to the inside face, or the outside face with the entry and exit wires fed through hole(s) allowing their entry into the junction box.

Junction box size may not only be dictated by the driver size, but also by the number of wires entering and exiting, the number of connections, and whether the downlight is listed for through-wiring. A downlight listed for through wiring allows the electrician to run a separate circuit through the junction boxes of other downlights. UL1598, para. 6.16 governs the maximum allowable number of wires or conductors and connections given the volume of the junction box.

Part #	Description
1213-X	Junction Box
1214	Cover
1215, 1223-X	Wireway

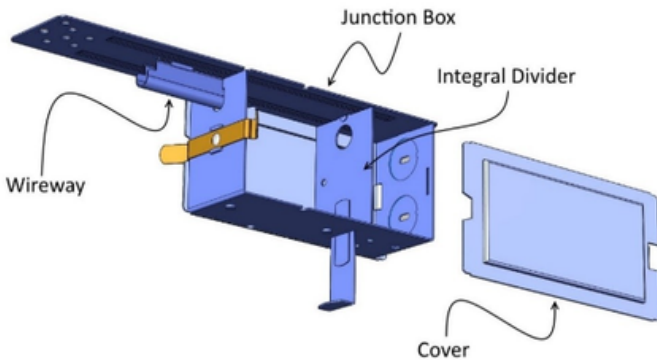

Fig. 9 Remodeler style Junction Box shown with, wireway, junction box cover, and line voltage entry via conduit and push-in connector

All junction boxes also contain knockout holes. Better junction boxes contain a combination of knockout hole sizes, for use with ½” trade conduit (0.875” actual hole size), as well as 9/16” holes permitting the installation of flex conduit using push-in connectors, and some styles of thermal protection, thermal cut-outs (TCOs) or other sensors. It is also generally desirable for knockout holes to be pushed outward¹ and contain a screwdriver slot for easy removal by prying out.

¹Punched outward, the knockouts most easily pass the knockout force resistance test prescribed by UL1598, para. 16.13.

Wire may pass from the junction box compartment to the housing either through a formed wireway as shown above, or through aluminum flex conduit.

6.3 Ceiling retention

The choice of housing or luminaire retention method is inherent in the OEMs downlight design. Typical methods include:

- Retaining Clips
- Double Slot Springs
- Mousetrap Springs

6.3.1 Retaining clips

Tripair Part# Z1652

With the housing or luminaire fully installed and held up to the ceiling, the retaining clip is rotated into each of the three t-slots from the inside, with the spring arm penetrating the outside of the housing. Using a short, small screwdriver, or the short end of a hex key, each of these is drawn downward. As the spring arm impinges on the top side of the ceiling, the housing becomes retained.

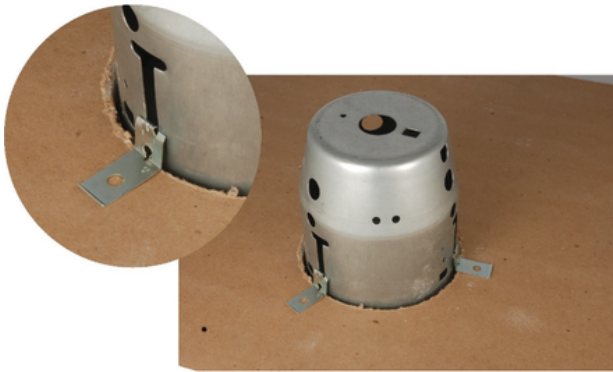

Fig. 10 Retaining Clip retention (Shown without Junction box for clarity)

6.3.2 Double slot springs

Tripair Part #PP265

Two of these, each located on opposing sides of the housing typically come preinstalled. As the housing is fitted through the ceiling hole, both springs will be pushed in slightly, permitting the housing to be fully inserted into the hole. Using a long Philips #2 screwdriver, or a cordless drill, turn each of the screws that are located in and near the top of the housing. As this is performed, the base of these springs will expand outward and impinge on the top side of the ceiling.



Fig. 11 Double Slot Spring retention (Shown without Junction box for clarity)

6.3.3 Mousetrap Springs

Tripair Part# PP174

These are bent torsion springs that are typically mounted on opposing sides of the luminaire, each having a lever arm. With this system, if a housing is used, it typically contains somewhat large square (e.g., 1" x 1") or rectangular cut-outs on opposing sides of the housing to allow the springs to penetrate.

The housing is placed and held in the ceiling hole, while the luminaire is held with the mousetrap springs vertical, and then slid into the housing. With the luminaire oriented so the springs can open and fall into the cut-outs in the sides of the housing, they will urge both the downlight and the housing up to the ceiling.

Part #	Description
PP174	Mousetrap Spring
0039	Spring Retainer



Fig. 12 Mousetrap Spring Retention (Shown without Junction box for clarity)

6.4 Luminaire retention for housing

With the exception of mousetrap springs, which hold both the housing and luminaire up to the ceiling, the luminaire must contain its own retention means, as well as allow removal for relamping or other servicing.

6.4.1 Housing springs

This system comprises three small formed springs that are riveted equally around the lower portion of the housing side wall, which also contains small cut-outs permitting the spring to penetrate into the housing. The luminaire body also contains an inward rolled bead.

With the springs and rolled bead manufactured at the designed height, the bead will pass just above the projecting springs, allowing it to be restrained as the top side of the luminaire trim contacts the ceiling.

Part #	Description
1230ZN-X	Housing
1204ZN-X	Trim Holder

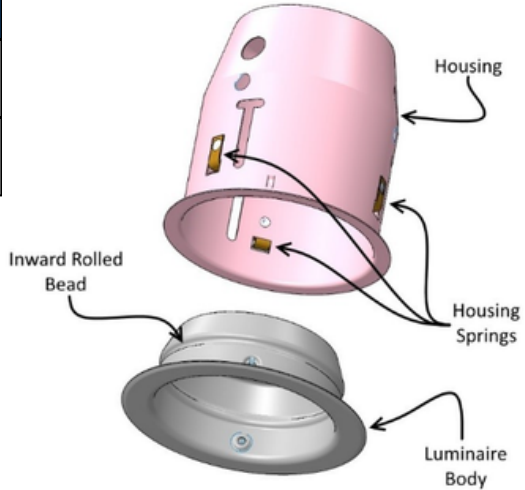

Fig. 13 Luminaire retention with housing springs

6.4.2 Trim springs

Tripair Part #0047-X

A patented system developed by Tripair (U.S. Pat. # 6,719,438), these are made from a flat piece of pre-hardened galvanized steel, formed with varying curves and containing projecting points. They are riveted to opposing sides of the luminaire, where both ends of both springs will impinge on the inside wall of the housing, providing four-point retention.

Part #	Description
1210ZN-X	Housing
0047-X	Springs
1211ZN-X	Trim Holder

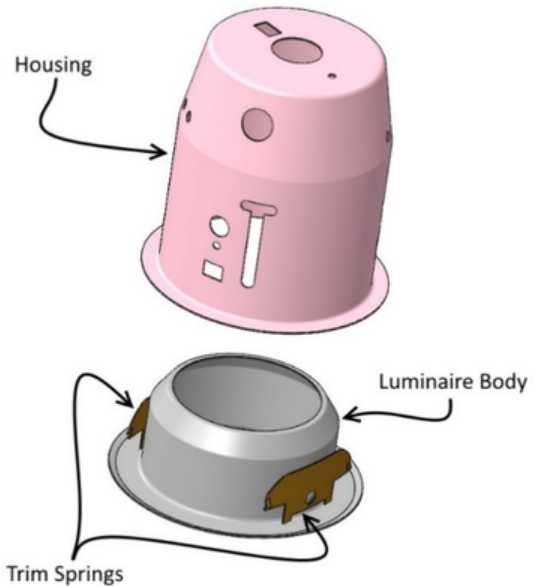

Fig. 14 Luminaire retention with curved trim springs

Unlike housing springs which rely on critical placement of springs, rolled bead, and installation, the trim springs are more forgiving in that they retain the luminaire at any position within the housing, including the all-important position of trim to ceiling contact.

6.4.3 Torsion springs

Tripair Part #PP398

With this system, the housing must contain two opposing inward projecting pairs of u-shaped bent tabs, located at the proper height to secure the luminaire. The luminaire must also have two opposing torsion springs on each side.

To install the luminaire, the ends of the torsion springs are squeezed together, allowing the free ends to fall into the u-shaped bent tabs. The hooked ends of the springs prevent the luminaire from completely falling out. As the luminaire is pushed up, the spring arms will open up, approaching a horizontal orientation, where the outward splaying force holds the luminaire up to the ceiling.

Part #	Description
1243-X	Housing
1221-X	Junction box
1222	Cover
PP398	Torsion Springs
	Luminaire

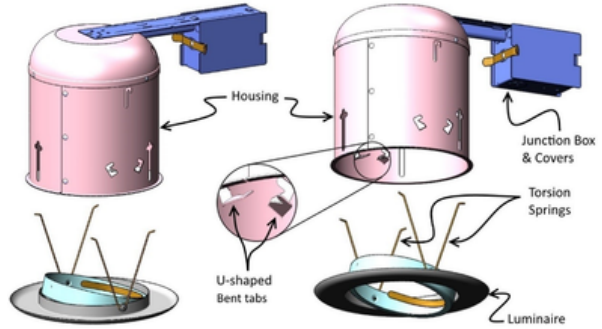

Fig. 15 Luminaire retention with torsion springs

An alternative to integral U-shaped bent tabs to secure the luminaire, torsion spring brackets may be riveted to the face or sides of the light fixture or luminaire.

Part #	Description
1231-X	Plaster frame
PP398	Springs
1450-1	Bracket

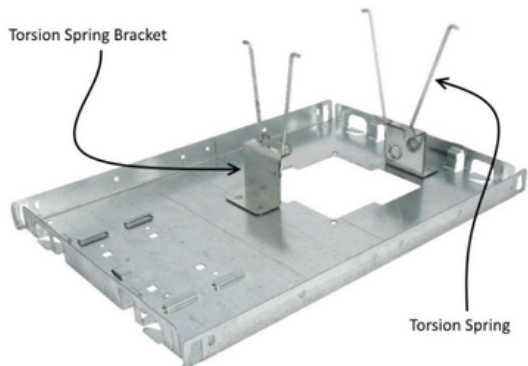

Fig. 16 Torsion spring brackets

7. Downlight assemblies: new construction, non-IC

Non-IC luminaires are permitted in ceilings where no insulation is in contact with the downlight, and no other municipal or state laws impose additional requirements¹. This typically consists of either a steel plaster ring, or a plaster frame (or “tray”), either of which rests on the top side of the ceiling, in which an aperture or hole through the plaster frame or plaster ring and ceiling permits the installation of the downlight.

¹Though UL1598 is the principle specification governing luminaires, additional institutional, municipal, and/or state laws can impose further requirements, thus there is unfortunately no absolute national standard.

7.1 Plaster rings

Better plaster rings contain, either integral or the ability to add:

- A throat height (the vertical portion of the ring) of at least 1” in order to accommodate a ceiling that has two ½” sheets of drywall or ceiling tile.
- Reflector retention springs.
- Brackets to permit vertical adjustment
- Junction box

Part #	Description
1401-X	Ring
1232-X	Junction Box
1242	Cover (External)
1242-X	Cover (Internal)
1253-1	Straight Bracket
1254	Butterfly bracket



Fig. 17 Plaster Ring Assembly; Left without reflector installed, right with reflector installed

Plaster rings however do not readily comply with airtight requirements, nor have easy provision for.

7.2 Plaster frames

Better plaster frames contain;

- Formed edges on all sizes for maximum rigidity.
- Integral junction boxes or the ability to attach such.
- Bar Hanger pockets: to accommodate bar hangers or mounting bars that slide in at opposing ends of the frame, whose ends have a variety of attachment means to support the frame to the ceiling structure.
- Integral means of locking the bar hangers.
- Butterfly Brackets or the ability to attach such; brackets that mount to two opposing sides of the frame that permit vertical adjustment of the frame, also permitting a variety of attachment means to support the frame to the ceiling structure.

Properly designed downlight assemblies result in the bottom face of the plaster frame being;

- For wood joist ceilings: Flush with the bottom side of the joist, enabling drywall to be unobstructively installed, and the plaster frame in direct contact with the drywall.
- For suspended or T-Bar ceiling: Flush with the top side of the ceiling tile.

Part #	Description
1231-XX	Plaster frame
1232-X	Junction Box
1242	Cover (External)
1242-X	Cover (Internal)
1253-1	Straight Bracket
1254	Butterfly bracket
1287	Bar Hangers

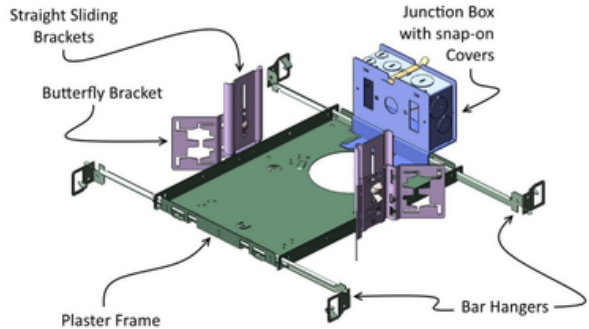

Fig. 18 Plaster frame assembly



High-end OEMs like to emboss their name/logo on the plaster frame (and other parts.) [See brand embossing.](#)



Plaster frame hole sizes

The main hole in the plaster frame is determined by the OEM's downlight design; large enough to allow the body of the luminaire to pass, but small enough so that the luminaire trim conceals the hole. This main hole will also be used by the ceiling installer as a template for cutting what will become the same size hole in the ceiling tile or sheet.

In practice, the recessed fixture is first suspended from the ceiling joists, T-Bar, or other structural ceiling element, adhering to the architectural or lighting layout plan. As the ceiling tile or sheet is installed, the ceiling installer marks out on the ceiling the approximate location of the hole(s) in each plaster frame (which is resting just above the ceiling). This allows the installer to use a laminate trimmer or other rotary tool to pierce the ceiling in that approximate location. Working blind as to the precise boundary of the hole in the plaster frame, the installer moves the trimmer in any direction, until it has contacted the edge of the plaster frame hole. This will be obvious upon it making the telltale sound that any rotating bit makes when it contacts metal, at which point the hand guides the trimmer while keeping contact with the metal, using it as a template to cut the complete perimeter of the required hole.

Integral flange

Some plaster frames contained an integral flange around the main hole.

Advantages include;

- The flange covers the edge of the hole in the ceiling tile, offering a cleaner finish and less susceptibility for dust to fall into the room; something which is rarely an issue once the fixture is installed.
- Some flanges contain four small notches in the side of the flange that are typically 90° apart to one another. These are often referred to as “gunsights”, the purpose of which is to help ensure a perfect line of adjacent fixtures where required, whereby the line of fixtures is adjusted to have opposing notches fall on a preplanned laser sight line.

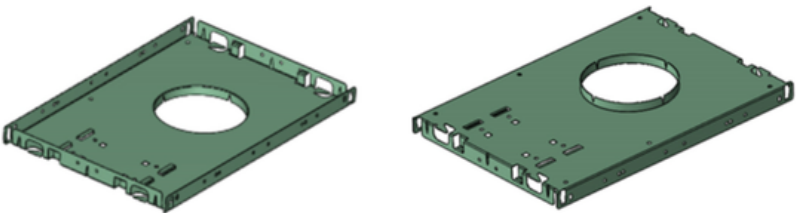

Fig. 19 Plaster frame with flange holes and “gunsights”

The only downside to having a flange is cost, as creating this typically requires an extra operation.

Forming the flange (without gunsights), can be achieved from either a laser cut or stamped hole in the plaster frame, followed by forming the flange.

Forming the flange with gunsights, requires the hole to be laser cut only, as the fine notches are typically done while the plaster frame is in its flat state, followed by forming the notched flange.

No matter the kind of plaster frame, the hole in the ceiling will match the hole in the plaster frame, therefore the choice of plaster frame hole size must be;

1. Large enough allow the body of the luminaire to pass through. This must include any projecting features (e.g., rivets or body of torsion springs).
2. Small enough so the trim of the luminaire will full conceal the perimeter of the hole.

If/where there is sufficient difference between points 1 & 2 above across several models of luminaires, it may be possible to use a plaster frame with a common hole size; the largest hole size that can accommodate a range of fixtures, provided the trims sufficiently cover this hole size, even if the luminaire is inadvertently installed off-center with respect to the plaster frame hole.

Plaster frames come in a variety of sizes, mainly dictated by the hole size. For example, Tripar offers the following principle sizes.

7.2.1 Small Plaster frame (7-1/2" x 10-1/8")

Tripair Part#1241-XX series

Available with or without integral junction boxes

Part #	Description
1241-X	Plaster frame with Junction Box
1287	Bar Hangers

Note: Not compatible with any standard IC Box. Custom IC box possible, but non-airtight only, due to plaster frame having bar hanger pockets on all four sides.

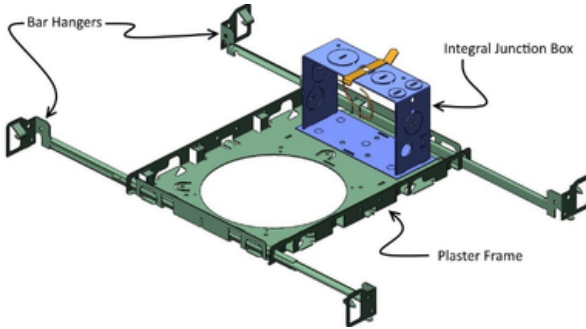

Fig. 20 1241-XX series Plaster Frame with integral junction box

7.2.2 Medium plaster frame (8-5/8" x 12-1/2")

Tripair Part # 1231-XX & 1286-XX series

Compatible with a variety of junction boxes and IC boxes; non-airtight, reduced airflow, and Ultra-airtight IC:

Part #	Description
1231-XX	Plaster frame
1232-X	Junction Box
1242	Cover (External)
1242-X	Cover (Internal)

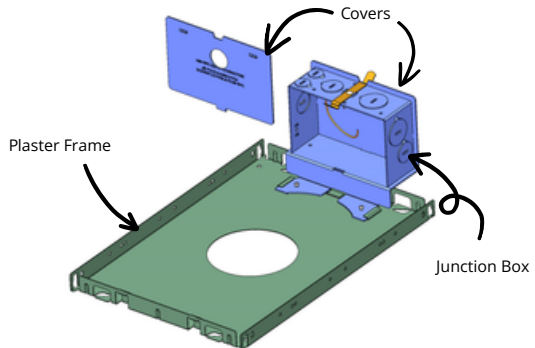

Fig. 21 1231-X Plaster Frame shown with 1232 junction box & 1242 series junction box covers All are available with a variety of standard hole sizes. Custom hole sizes (of any shape, round, square, irregular) are also possible; either die punched or CNC laser cut, even with multiple holes.

Smart buy

7.2.3 The Shutter™ plaster frames (8-5/8" x 12-1/2")

Alternately, a plaster frame containing an adjustable round or square hole may be employed; Tripar's Shutter™*. These employ a series of leaves or moveable plates; whose adjustment allows a range of hole sizes. The lighting OEM would typically adjust the hole size for one or each of their luminaires, not leaving this to the installer, as an incorrectly sized hole can cause consideration job site problems.

The unit cost for an adjustable hole plaster frame may be more than one with a fixed hole size, but can have the following advantages:

- Avoids OEM having to try to predict plaster frame hole requirements, often problematic on new products.
- Reduces the number of plaster frame SKUs.
- Avoids OEM being left with surplus plaster frames containing certain hole diameters, and shortfalls on others which can only be corrected upon ordering and receiving subsequent orders.
- To serve as back-up if/when an OEM temporarily runs out of a specific high volume plaster frame hole size.

As shown in the figures below, this size plaster frame is available in two styles:

- [Adjustable round hole](#)
- [Adjustable square hole](#)

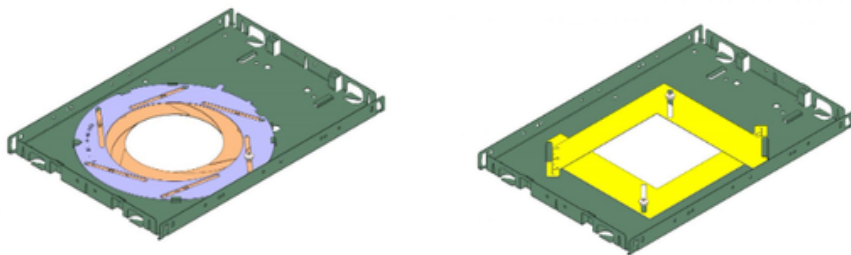

Fig. 22 Adjustable hole plaster frames

*Patented
TriparInc.com/PAT



Most OEMs buy 500-2000 and keep them in stock. They found it was better to keep client orders moving instead of having their entire production halted by missing plaster frames of various hole sizes (worth a few dollars.)

7.2.4 Large Plaster frame (12-1/8" x 15-5/8" + Longer)

Tripair Part #1483-1-XX series

The 1483 series plaster frames are bent on four sides, contain integral bar hanger pockets, and a host of other benefits; learn about it our [New Product Bulletin](#).

*1483-XX can be produced in any length from 15-5/8", up to 96".

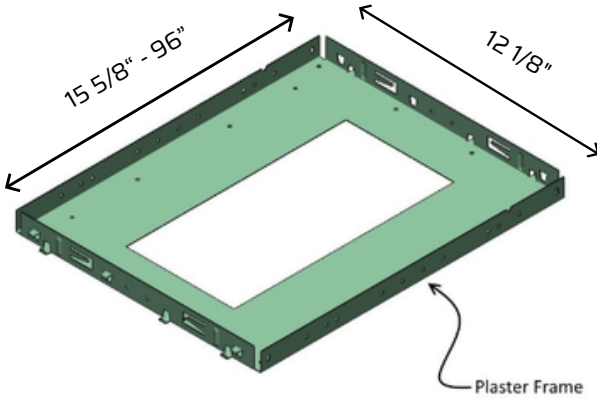

Fig. 23 1483-1-XX Plaster Frame

This plaster frame can be used on its own for non-IC application and is also compatible with a variety of reduced airflow/Chicago Plenum and Ultra-airtight IC boxes. Available with a variety of standard hole sizes. Custom hole sizes (of any shape, round, square, irregular) are also possible; either die punched or CNC laser cut, even with multiple holes.

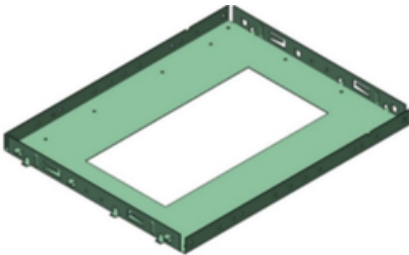

Fig. 24 1483-1-XX series Plaster Frame

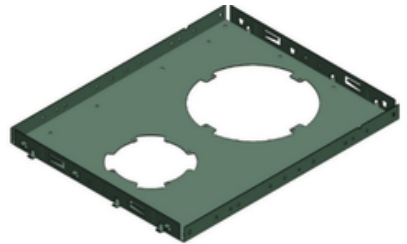

Fig. 25 1483-1-XX series Plaster Frame with double and irregular holes

7.2.5 T-Grid Plate

Need to anchor a driver, battery pack, or other device above T-Bar drop ceiling?

Use our customizable T-Grid Plate with a pair of bar hangers! Integral bar hanger pockets on opposing sides accept our proven 1287 bar hangers; extendable from 14" to just over 24", and offer a variety of mounting features, including notches for resting on T-Bar.

T-Grid plate ends may be flat or bent up 90°. Kept flat, the plate measures 14" long, allowing the device to overhang the plate if needed. Bent up, the plate measures 12" long, creating a pocket for the device thus limiting its length, but is an option to increase rigidity as plate width and device weight increase.

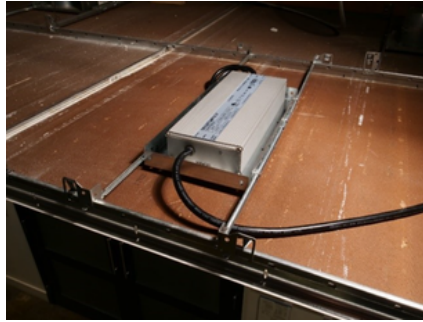

Fig. 26 #1405-6 with #1287 bar hangers installed in drop ceiling

Item	Description
1405-X	T-Grid Plate, 12-1/8" long x custom width
1405-X-FE	T-Grid Plate, flat ends, 13-7/8" long x custom width

Note: Replace X with width required; e.g. 1405-2-FE for 2" wide flat plate with flat ends.



Fig. 27 1405-2-FE with #1287 Bar hangers



Fig. 28 #1405-6

7.3 Housing, Reflector & luminaire retention in plaster frames

These all must be installed from the bottom (room-side) of the ceiling, and also be removable for servicing. The requirements and methods differ for holding housings, aluminum reflectors, and luminaires.

7.3.1 Housing Retention

The same three methods of holding housings for retrofit or remodeler may also be used for new construction once the plaster frame and ceiling panel are installed;

- [Retaining Clips Z1652](#)
- [Double Slot Springs PP265](#)
- [Mousetrap Springs PP174](#)

In addition, there is a fourth way, using another style of retaining clip, [Retaining Clips Z1592](#).

Some plaster frames have three lanced pockets, equally spaced around the periphery of the main hole. These may be used to hold Retaining Clips Z1592 and are intended to hold only housings which contain side slots (normally T-slots). With the T-slots in the housing approximately oriented with the retaining clips, the housing is simply pushed up into the hole in the ceiling until the housing flange contacts the ceiling.



Fig. 29 Z1592 Retaining Clip installed in plaster frame

Looking up into the housing will permit seeing if the ends of the retaining clips have fallen into the T-slots; if not, rotate the housing slightly until they do, obtaining full retention.

To remove, forcibly pull the housing downward, or rotate it slightly to disengage the retaining clip from the T-slots, then pull the housing downward.

7.3.2 Reflector retention

Reflectors are typically made from aluminum, made by spinning, followed by painting, anodizing and/or polishing to exhibit the desired aesthetic and photometric properties. They also typically have the luminaire attached to the top or in the upper neck of the reflector, so it is the reflector body that is secured to the ceiling through different type of clips.

7.3.2.1 Aluminum Reflector Retention to Plaster Frames

The two most common methods of retaining aluminum reflectors to plaster frames are

- Roto-Clips
- Linear Clips

Roto Clip

This method employs four U-shaped flat springs, commonly known as Roto-Clips (for an example see [Tripar's Z1653 Roto-Clip](#); that are riveted to the top side of the plaster frame, equally spaced around the main hole in the plaster frame. This permits them to be rotated out of the main hole so the hole in the ceiling tile can be cut without obstruction, and then be rotated so their ends project into the main hole. The ends of the spring have an outwardly projecting angled tooth that bites into the outside of the aluminum reflector as it is pushed up into the ceiling.



Fig. 30 Roto-Clips on Plaster Frame

The rivet hole in the roto-clip is typically located off-center, so that the degree of interference with the reflector can be changed as the roto-clip is rotated through 180° , offering two different retention forces applied to hold the reflector, the choice of which is decided by the installer.

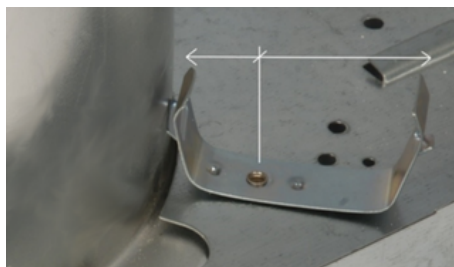

Fig. 31 Roto-Clip; Note distance offset from rivet hole to ends

To remove the reflector, simply place your hands inside the reflector and using friction, turn the reflector counterclockwise. This will cause the roto-clips to also turn out of the way allowing the reflector's removal, and/or the angled teeth on the ends of the roto-clips will create a helix as the reflector progressively descends as it is "unscrewed".

Linear Clip

A patented system developed by Tripar (U.S. Pat. #7,374,308), employs four linear leaf style springs (0043) which are slid into four lanced pockets around the plaster frame hole (1431-X). They begin being fully retracted so the hole in the ceiling tile can be cut without obstruction. The ends of each are then squeezed together to allow the spring to be slid forward, the degree of which is decided by the installer given the reflector retention force desired.

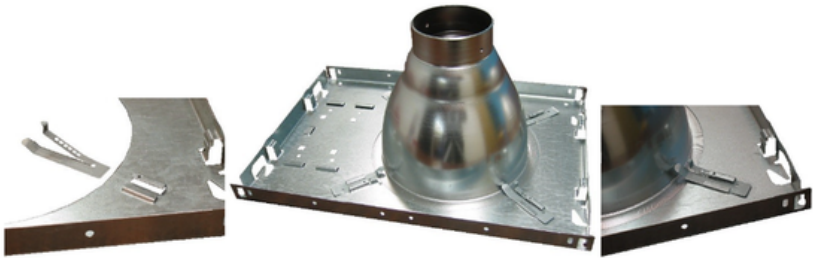

Fig. 32. 0043 Linear Clips on plaster frame 1431-X

[The differences and benefits of linear clips over roto-clips are best explained in the New Product Bulletin that introduced the Linear Clips.](#)

7.3.2.2 Aluminum Reflector Retention to Plaster Rings

The most common methods of retaining aluminum reflectors to plaster rings is using dual point retention springs. The center of these springs is typically riveted to cut-outs that are equally spaced around the throat of the ring. The cut-outs also provide for passage of each of the free ends of the springs, which also have projections that bite into the reflector.

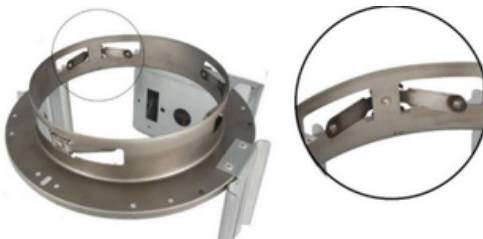

Fig. 33 Dual Point Retention Springs on Plaster Ring

The vertical height of the ring is adjusted so that the springs deflect and hold the reflector as it is pushed in, and the reflector flange contacts the ceiling.

7.3.3 Luminaire retention

Many OEMs include a retention system within their luminaire. The two most common are;

- Mousetrap Springs; Previously explained in Ceiling Retention
- Leaf Springs: These are two flat springs, riveted to opposing sides of the luminaire, with each spring having the bottom edge cut at a low angle. Fingers are used to urge the spring tips inward as the luminaire is placed into the ceiling hole, encouraged with a clockwise rotation. As the tips of the springs penetrate the topside of the ceiling and plaster frame, they will begin to splay outward, at which point the angled cut edge will draw the luminaire to the ceiling.

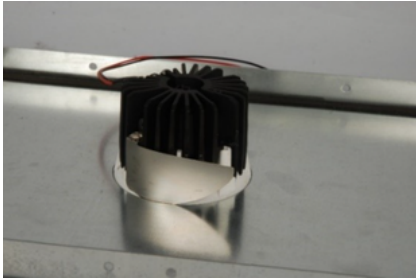

Fig. 34 Leaf spring

Removal is achieved by simply turning the luminaire counterclockwise and drawing it downward.

7.4 Junction boxes

Most plaster frames and plaster rings come with or have provision for a junction box to be added, typically placed near one end of the plaster frame or outboard of the plaster ring. The purpose of the junction box is to permit entry of line voltage (120VAC) as per governing electrical code requirements, and connection to the luminaire or other electrical components such as transformer, ballast or driver. Junction boxes, which are attached to the plaster frame or plaster ring, are typically placed as far away as possible from the luminaire in order to keep the driver or ballast from overheating.

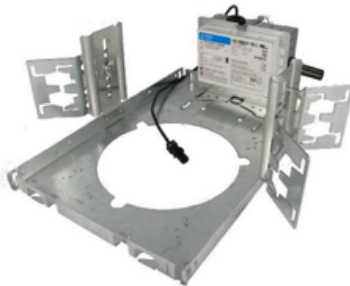

Fig. 35 Plaster Frame with junction box



Fig. 36 Plaster Ring with junction box

*The driver is often affixed to the outside face of the inner junction box cover

Both sides of the junction box typically accept snap-on covers, permitting toolless installation and removal. As per UL1598, para. 11.3, both the junction box and cover must be at least .05" thick if made of steel, and .09" if made of aluminum.

Junction box size may not only be dictated by the driver size, but also by the number of wires entering and exiting, the number of connections, and whether the downlight is listed for through-wiring. A downlight listed for through wiring allows the electrician to run a separate circuit through the junction boxes of other downlights. UL1598, para. 6.16 governs the maximum allowable number of wires or conductors and connections given the volume of the junction box.

All junction boxes also contain knockout holes. Better junction boxes contain a combination of knockout hole sizes, for use with ½" trade conduit (0.875" actual hole size), as well as 9/16" holes permitting the installation of flex conduit using push-in connectors, and some styles of thermal protection, thermal cut-outs (TCOs) or other sensors. It is generally desirable for knockout holes to be punched outward¹ and contain a screwdriver slot for easy removal by prying out. Wire may pass from the junction box compartment to the housing, typically through aluminum flex conduit.

¹Punched outward, the knockouts most easily pass the knockout force resistance test prescribed by UL1598, para. 16.13.

7.4.1 Junction box covers

Junction box covers can either be solid (no holes) or contain a variety of holes & cut-outs which serve to allow mechanical attachment of drivers or other electrical devices and/or wire passage.

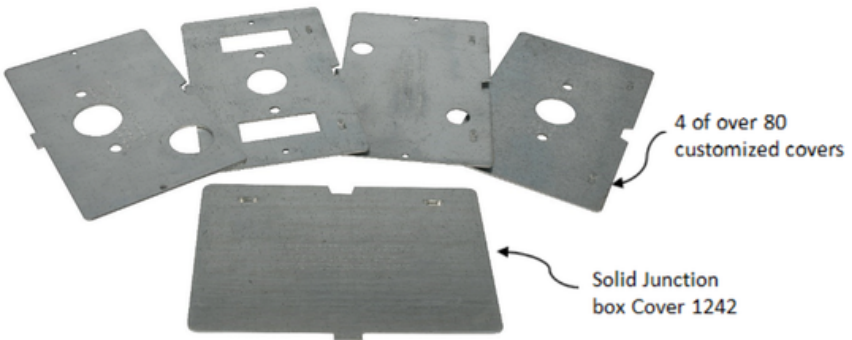

Fig. 37 Sampling of Junction Box Covers for 1232-X series Junction Box

The driver is often affixed to the outside face of the inner junction box cover; that being the cover that is closest to the plaster frame or plaster ring hole.



Fig. 38 Driver affixed to outside face of Inner junction box cover (1242-18), mounted to junction box 1232

The inner junction box cover must also have holes for both mechanically attaching the driver to it, as well as holes or slots to allow the driver wires to enter and exit the junction box. Besides Tripar's 1242, a solid junction box cover with no holes that normally serves as the outer (far side) junction box cover, a huge array of junction box covers (1242-XX) are offered, (typically used as inner junction box covers), each having different hole & slot cut-outs to accommodate a great range of drivers.

Affixing the driver to the inner junction box cover is also best for servicing, since if the driver ever burns out and needs replacing, the luminaire is withdrawn, whereupon a hand may be inserted through the hole, allowing the inner junction box cover (with driver) to be accessed and unsnapped from the junction box, and lowered below the ceiling through the hole, where it is now fully accessible.



Fig. 39 Inner junction box cover (3D Cover #1242-18B) with mounted driver, removed for servicing below ceiling

The same may be able to be achieved if the driver is mounted to the inside face of the inner junction box cover, but only for smaller drivers, and for which the remaining junction box interior volume permits the required electrical connections.

To comply with UL1598, para. 11.3, all of Tripar's 1242-XX, 1410-X and 1420-X series of junction box covers are made from .05" minimum thickness galvanized steel.

7.4.2 Junction box size & volume

Junction box size may not only be dictated by the driver size, but also by the number of wires entering and exiting, the number of connections, and whether the downlight is listed for through-wiring. A downlight listed for through wiring allows the electrician to run a separate circuit through the junction boxes of other downlights. UL1598, para. 6.16 governs the maximum allowable number of wires or conductors and connections given the volume of the junction box.

Tripar offers a diverse range of junction box sizes and styles; the most common of which are:

Description	Part Number	Dimensions		
		Width	Height	Depth
Standard J-Box	#1232-XX Series	4-7/8"	3-1/8"	1-3/4"
Junction Box & Twist 32™	1532 & 1532T (rotatable)	7-7/8"	2-3/8"	1-5/8"
Large Junction Box & Twist 64™	1432 & 1432T (rotatable)	7-7/8"	4"	1-7/8"
Universal Junction/Driver Box	1410-X	8" - 120"	2-3/8"	1-5/8"
	1420-X	8" - 120"	4"	2"
Smallest J-Box	#1257-XX	2-7/8"	1-13/16"	1-7/16"
Largest J-Box	#1062	7"	5-1/8"	3"

The above do not include Gasketed Airtight Junction Boxes. See section 8.9 for more info.

7.4.3 Standard Junction Box #1232-XX

A common size is 4-7/8" wide x 3-1/8" tall x 1-3/4" deep, Tripar's 1232-XX series. These typically contain either a Z-shaped bracket or a flat bracket. The Z-shaped bracket is typically used on plaster frames so that the body of the junction box is raised above the sides of the plaster frame and/or any adjacent T-Bars in suspended ceilings, also enabling easier installation and removal of the junction box covers.

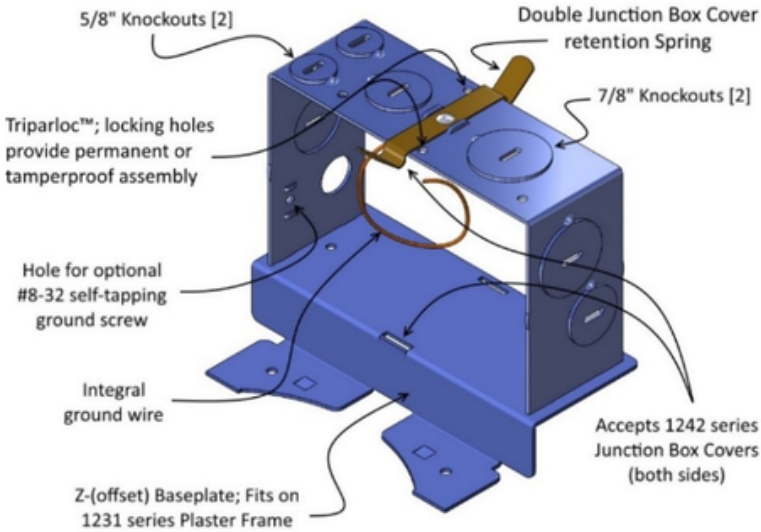

Fig. 40 Tripar's #1232-10 junction box

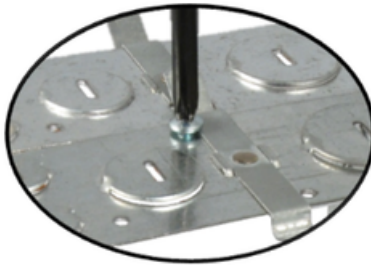

Fig. 41 Triparloc™

Triparloc™ New Product Bulletin

7.4.4 Volume Expansion of Standard J-Box #1232E & 1242-XXB

To make the junction box deeper in order to accommodate more wiring and connections, and/or internally mounted drivers, some OEMs double up the same junction box, (which keeps the same width and height, but doubles the depth), riveting them together and lengthening the cover retention spring. This predetermines the purpose of this double depth box.

Tripac instead offers two alternate solutions, both of which can be added by the OEM upon assembly, keeping inventory as flexible as possible. These are:

- Extender Box 1232E: This is virtually the same as the base 1232-XX series junction box and has provision to snap-on to the 1232-XX base junction box, effectively doubling its interior volume.
- 3D Covers 1242-XXB: These are formed covers, having a depth of 1". They too can be snapped on to the base 1232-XX series junction box, adding approximately 50% interior volume.



Fig. 42 Left Extender Box 1232E



Fig. 43 3D Cover 1242-25B

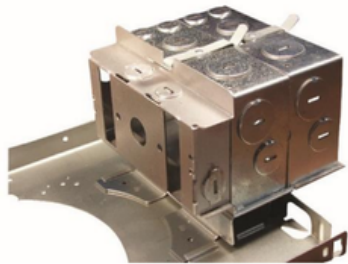

Fig. 44 1232 Junction Box with 3D Cover 1242-25B mounted to the inside (left) face, and Extender Box 1232E to the outside (right) face

To comply with UL1598, para. 11.3, all of these are made from .05" minimum thickness galvanized steel.

The 3D covers can also be snapped onto Extension Box 1232E, offering almost limitless volume expansion. Both are further explained in the [New Product Bulletin that introduced them](#).

7.4.5 Large Junction Boxes

- # 1532 & Twist 32™ #1532T (7-7/8" L x 1-5/8" D x 2-3/8" T)
- # 1432 & Twist 64™ #1432T (7-7/8" L x 1-7/8" D x 4" T)

A longer and/or larger junction box may be required not only to accommodate a larger driver, but also by the number of wires entering and exiting, the number of connections, and whether the downlight is listed for through-wiring. Either size may be mounted directly to the plaster frame, elevated and fixed to our Z-bracket, or elevated and rotatable on our Z-bracket, facilitating both line voltage installation by the electrician, as well as improved servicing access by rotating it toward the ceiling opening.

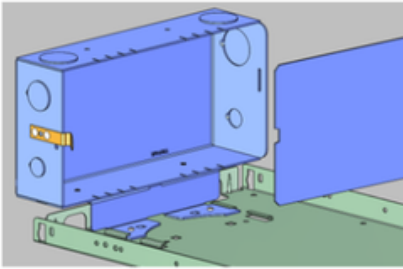

Fig. 45 1432 Junction Box

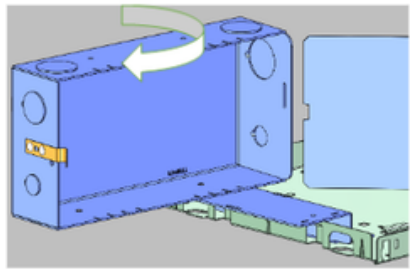

Fig. 46 1432T junction box

For servicing in very small ceiling openings (2-3/4" or 70mm), where a hand can't fit, use the 1532 Twist 32 with its 2-1/2" wide cover; simply hook a bent coat hanger wire onto the T-wing and pull to rotate the Twist until the free end is over the hole, where the cover may be unlatched and lowered.

More information can be found in our [New Product Bulletin here](#).

7.4.6 Volume Expansion of gasketed (airtight) J-Box

The gasketed junction box that comes affixed to the Reduced Airflow and Ultra-Airtight IC Boxes may also be expanded; see section 8.9.

7.4.7 The Universal Junction/Driver Box

The Universal Junction/Driver Box

This is the most innovative and flexible, offered in two sizes; the Small; measuring 2-3/8" wide x 1- 5/8" high, and the Large; measuring 4" wide x 2" high. Each of these is available in lengths from 8" to 120", to meet wide-ranging lighting OEM requirements, and include a host of additional innovative features; see section 10.1 for complete details.

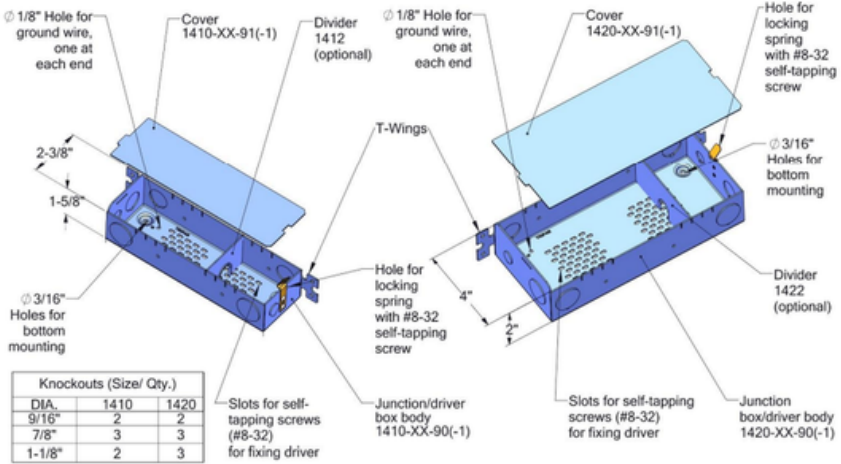

Fig. 47 1432 Universal Driver/Junction Box



Fig. 48 Mounted to plaster frame with driver installed to cover



Fig. 49 Mounted to T-Bar using the integral T-Wings

*Patent pending

7.4.8 Smallest J-Box #1257-XX

Tripair's smallest junction box is item # 1257-XX at 2-7/8" long x 1-13/16" wide x 1-7/16" deep.

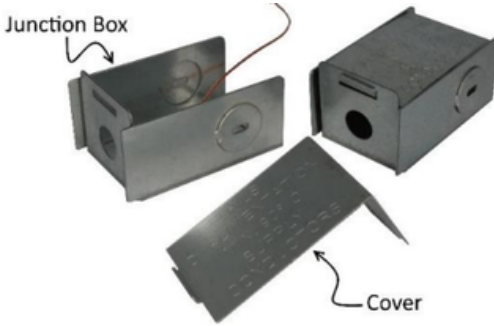

Fig. 50 1257-1 Junction Box & 1258 Cover

7.4.9 Largest J-Box #1062

Tripair's largest junction box is item # 1062 at 7" x 5-1/8" x 3" deep.



Fig. 51 1062 Outlet Box, with 1063 Cover & 1064 Internal Divider

See all our junction boxes offered

8. Downlight assemblies: New construction, insulated ceiling

When there is insulation in the ceiling, the top side of the luminaire must be enclosed by a metal barrier or enclosure, commonly known as an IC box. Depending on a host of factors, such as heat output, ventilation, and most importantly, any municipal or state laws¹ that impose airflow restrictions, the enclosure may or may not need to have airflow restrictions.

There are three types of such enclosures;

- Non- Airtight
- Reduced Airflow
- Ultra-Airtight (<2CFM)

8.1 IC Non-Airtight

When there is insulation in the ceiling, the top side of the luminaire must be enclosed by an IC box. If there are no municipal or state laws that impose airflow restrictions, the enclosure need not be airtight.

Tripar offers a knockdown non-airtight IC Box, made up of two flat and scored pieces, 1233-1-XX and 1233-2-XX. Each piece folds by hand along perforated and scored fold lines to form two U-shaped pieces. When the inner piece is slid into the outer piece, the pair form an open IC box, 6-3/4" deep.

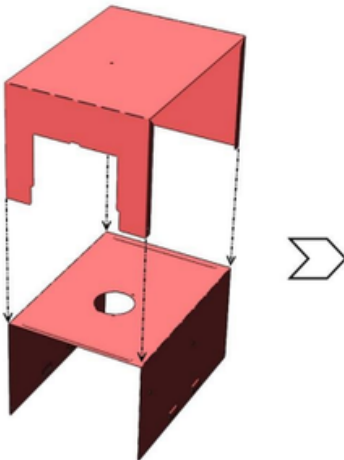

Fig. 52 Knockdown IC Box Exploded

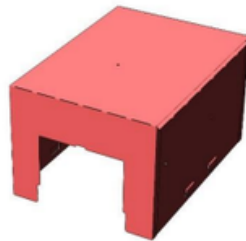

Fig. 53 Knockdown IC Box Assembled

These non-airtight IC Boxes accept Tripar's 1231-X series plaster frames (fixed or adjustable hole), which in turn accept the 1232-X series junction box. When the plaster frame (with riveted junction box) is placed on the open face of the IC box, the plaster frame may be riveted to the open box, forming a non-airtight IC Box.

Part #	Description
1233-1-10	Knockdown I.C. Box Part A
1233-2	Knockdown I.C. Box Part B
1232-X	Junction box
1242	Cover (External)
1231-X	Plaster Frame

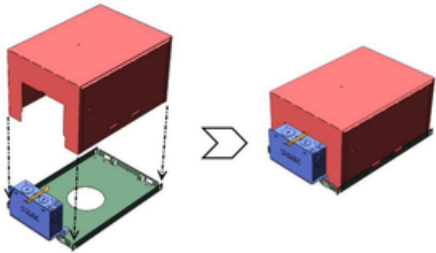

Fig. 54 Knockdown IC Box with j-box; exploded & assembled

The plaster frames that mate with this knockdown IC Box are the 1231-X series, which accept;

- The 1232-X series junction boxes that contain the Z-shaped baseplate (ref fig. 40)
- These junction boxes accept all 1242-X series of covers and cover accessories explained in section 7.4.1
- Bar hangers 1240, 1287 and 1487 explained in Downlight Suspension, section 9.1.
- Vertical adjustment brackets 1253 explained in section 9.2, which in turn accept the
 - 1054 Caterpillar Bracket and 1287 Bar Hangers, or
 - 1254 Butterfly Bracket and either the 1287 Bar Hangers or 1487 L-Bars™

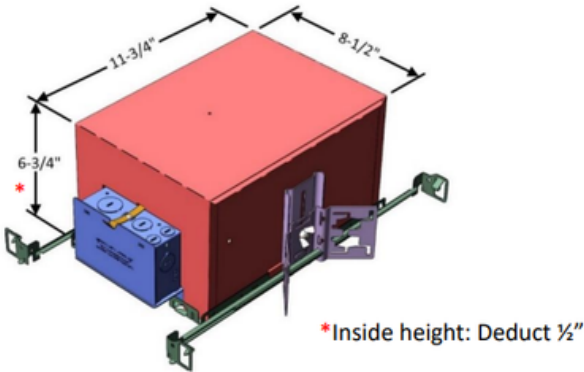

Fig. 55 Knockdown IC Box with Plaster Frame, J-box, Sliding Brackets, Butterfly Brackets, and bar hangers

8.2 IC, Reduced Airflow & Ultra Airtight

When there is insulation in the ceiling, and municipal or state laws¹ impose heat retention or airflow restrictions, the luminaire must be enclosed by an IC Box that suitably restricts airflow.

¹Though UL1598 is the principal specification governing luminaires, additional institution, municipal, and/or state laws can impose further requirements, thus there is unfortunately no absolute national standard.

Difference in Reduced Airflow & Ultra-Airtight IC Boxes

The Reduced Airflow IC Boxes and the Ultra-Airtight IC Boxes both share a similar design and construction, including;

- Press break formed corner folds throughout
- Overlapping joints
- Integral gasketed junction box

With such construction, airflow is reduced by not guaranteed to any particular specifications. When there is insulation in the ceiling, and municipal or state laws¹ impose heat retention or specific airflow restrictions, (e.g. < 2 cfm under pressure (vacuum) of 1.57lbs/ft², ref. Florida Building Code Chapter 13 “Florida Energy Efficiency for Building Construction”, section 13-606.1.ABC.1.2.4 Recessed lighting fixtures), the luminaire must be enclosed by a metal barrier or enclosure (IC Box) that restricts airflow to the applicable specification(s).

This is where Tripar’s Ultra-airtight IC Boxes (those containing “AT” in their part number suffix) come into play, which contain the same components as the Reduced Airflow IC Boxes, but also have caulking applied to all interior joints. Plaster frames containing “AT” in their part number suffix also have gasketing added to the perimeter of the underside where it contacts the IC Box to which it is riveted.

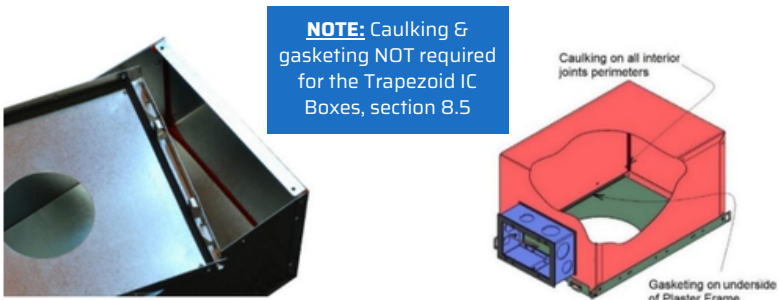

Fig. 56 1681-XX or 1685-XAT series Ultra-airtight IC Box (with integral gasketed junction box) with 1286-XAT series plaster frame mounted

The combination of these have been tested and meet the < 2 cfm airflow requirements. It is however important for the lighting OEM to ensure that any opening specified or added to accept the luminaire or any other device, still maintains the required airflow integrity.

The following sections (8.4-8.8) introduce the different sizes and configurations of Tripar’s Reduced Airflow & Ultra-Airtight IC Box line. See section 8.3 for an IC Box Model Comparison table that conveniently illustrates all currently available standard options.

8.3 IC Box Model Comparison

We have introduced an increasingly broad range of UL1598 compliant IC Boxes over the years; both Chicago Plenum & Ultra Airtight series (< 2 cfm airflow), through no less than five New Product Bulletins. The chart allow you to select your optimal solution, based on your requirements of:



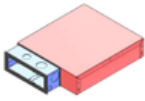
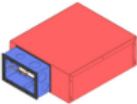
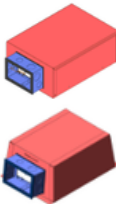
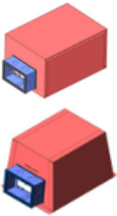

- IC Box height
- IC Box size (width x length)
- IC Box Finish (Galv or black)
- Junction Box size (all of which have volume expansion)

IC BOXES	“MINI” 1775 series	“ULTRA-SHALLOW” 1485 series	“STD. SHALLOW” 1685 series & 1785 Trapezoidal series	“STANDARD” 1681 series & 1781 Trapezoidal series
				
Height	2-1/4"	3-1/2"	4-3/4"	6-3/4"
Size (W x L)	8-1/2" x 9-5/8"	8-1/2" x 9-5/8"	8-1/2" x 11-3/4" 8-1/2" x 10-1/2"	8-1/2" x 11-3/4" 8-1/2" x 10-1/2"
Std. J-Box 27 cu.in Galvanized	n/a	1485-11 (AT) 1485BL-11 (AT) ¹	1685-11(AT) 1685BL-11(AT) ¹ 1785-11 ² 1785BL-11 ²	1681-11(AT) 1681BL-11(AT) ¹ 1781-11 ² 1781BL-11 ²
Large J-Box 70 cu.in Galvanized	n/a			1481-11(AT) 1481BL-11(AT) ¹
Slim J-Box 20 cu.in Galvanized	1775-11(AT) 1775BL-11(AT) ¹	Standard on the 1775-11(AT) Mini I.C.Box, available on all other I.C. Box sizes upon request		
Plasterframe	1286 series			

¹ I.C. box is pre-painted black, but the junction box and I.C. covers are galvanized (AT) indicates our Ultra-Airtight version (also <2CFM airflow)

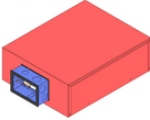
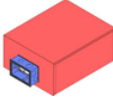
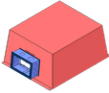
² Trapezoid IC Box (<2CFM airflow): Airtight J-Box does not come attached; sold separately [item#1281-92-1](#)

To see assemblies with all accompanying components (Plaster frames, J-Box Covers, Brackets, Bar Hangers, Volume Expansion), [please click here](#)

CONT.	“LARGE SHALLOW” 1684-12 series	“LARGE STANDARD” 1684-11 series	“LARGE TALL” 1682-11 series	“LARGE X-TALL” 1682-21 series
		 	 	
Height	5-1/8"	6-3/4"	8-1/2"	11-1/4"
Size (W x L)	12" x 14-3/4"			
Std. J-Box 27 cu.in Galvanized	1684-12(AT) 1684BL-12 ¹	1684-11(AT) 1684BL-11(AT) ¹ 1784-11 ² 1784BL-11 ²	1682-11(AT) 1782-11 ² 1782BL-11 ²	1682-21(AT) 1682BL-21(AT) ¹
Large J-Box 70 cu.in Galvanized	n/a	1484-11(AT) 1484BL-11(AT) ¹	1482-11(AT) 1482BL-11(AT) ¹	1482BL-21 ¹
Slim J-Box 20 cu.in Galvanized	Standard on the 1775-11(AT) Mini I.C.Box, available on all other I.C. Box sizes upon request			
Plasterframe	1486 series			

¹ I.C. box is Pre-painted black, but the junction box and covers are galvanized (AT) indicates our Ultra-Airtight version (also <2CFM airflow)

² Trapezoid IC Box (<2CFM airflow): Airtight J-Box does not come attached; sold separately [item#1281-92-1](#)

To see assemblies with all accompanying components (Plaster frames, J-Box Covers, Brackets, Bar Hangers, Volume Expansion), [please click here](#)



To save time and cost, many lighting OEMs use our IC boxes and UL1598 assemblies as the base for their products. Some even take our stocked items (48-hour lead time) and call it a day.

8.4 Standard Size

The 1681 IC Box (6-3/4" high), and 1685 (4-3/4") series are 11-3/4" long x 8-1/2" and accept the 1286 series of plaster frames (with integral bar hanger brackets.)

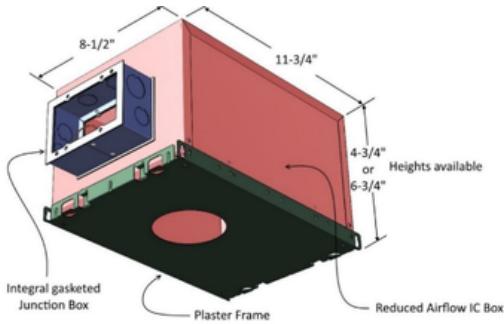

Fig. 57 1681-XAT series Ultra-Airtight IC Box with integral gasketed junction box and 1286 series plaster frame

Note: The following applies to both the Standard Size IC Boxes and Trapezoid IC Boxes (section 8.5): To maintain reduced airflow, Tripar's 1286-X series plaster frames have the same overall size and construction as the 1231-X series plaster frame, except they have all superfluous holes removed except that which the OEM specifies.

When riveted to any of Tripar's 1681-XX or 1685-XX, (or Trapezoid series 1781-XX or 1785-XX) series Reduced Airflow/Chicago Plenum IC Boxes, together they form a Reduced Airflow/Chicago Plenum compliant IC Box Assembly. Similarly, when riveted to any of Tripar's larger 1681-XAT, or 1685-XAT (or Trapezoid 1781-XX or 1785-XX) series Ultra-Airtight series IC Boxes, all with integral gasketed junction box (section 8.9), together they form Ultra-Airtight IC Boxes (< 2 CFM airflow).

8.5 Standard & Large Size - Trapezoid 2.0*

NEW

We pleased to introduce the Trapezoid IC box 2.0, now with breakthrough single-piece construction. The volume of IC boxes effectively shrouds the light fixture and dissipate heat, but poses two challenges; the space required in both shipping from the manufacturer to the lighting OEM and the inventory space.

A new solution is to use IC Boxes that are trapezoidal* in shape. These IC boxes nestable within 1" of one another; effectively reducing bulk shipping volume and storage space by a factor of 5-7X, for example:

Trapezoid IC Part #	Per pallet	Regular IC Box Part #	Per pallet
1781-11	512	1681-11	112
1785-11	576	1685-11	168

To permit nesting, these Trapezoid IC boxes come without the airtight junction box (part # 1281-92-1) installed, so the OEM only needs to pop rivet this on while assembling the rest of the fixture.

The 6° sloped sides and four small bent tabs in each bottom corner prevent nested Trapezoidal IC Boxes from wedging together. The sloped sides also enhance serviceability, with improved access & visibility to the inner junction box cover.

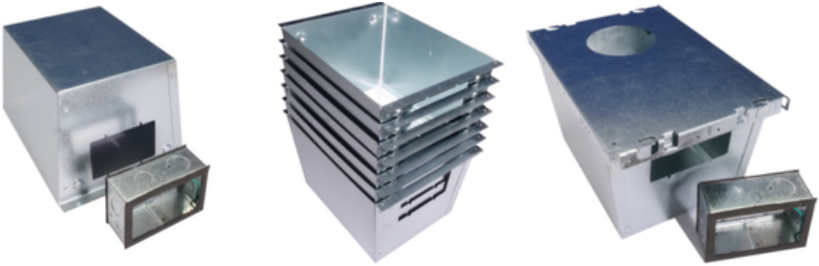

Fig. 59 Trapezoid IC boxes - Airtight & Nestable

IC Box Part #	Type of IC Box	BOX (Dims. In inches)			Fits w/Plaster Frame Series	Fits w/Airtight Junction Box	Fits w/ External Cover (Screw-on)	Fits w/ Internal Cover (Snap-on)
		Length	Width	Height				
1781-11*	Trapezoid	10-1/2"	8-1/2"	6-3/4"	1286-X	1281-92-1	1242-30	1242-31
1681-11(AT)	Standard	11-3/4"		4-3/4"				
1785-11*	Trapezoid	10-1/2"						
1685-11(AT)	Standard	11-3/4"						
1784-11*	Trapezoid	14-3/4"	12"	6-3/4"	1486-1-X	1281-92-1	1242-30	1242-31
1684-11	Standard			8-1/2"				
1782-11*	Trapezoid							
1682-11	Standard							

*No, it's not an oversight that we do not offer the 178X series Trapezoid IC Boxes in an AT (caulked) version - not needed to meet 2 CFM max airflow with our single piece construction! Larger plaster frames (1486 Series) available upon request. See our [New Product Bulletin](#) for more information.

*Patent pending
TriparInc.com/PAT

8.6 Large Size

The 1682 & 1684 IC Box series are both larger, 14-7/8" long x 12" wide, and accept the 1483 series plaster frames.

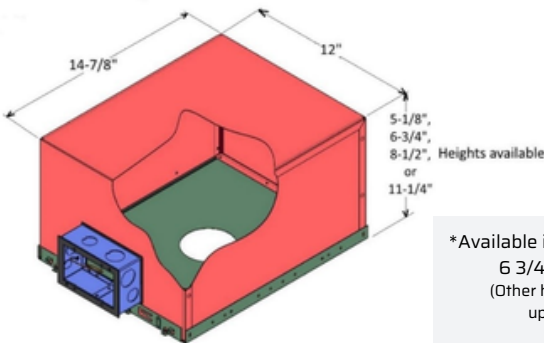

Fig. 58 1483-XAT series plaster frame mounted to 1682-XAT or 1684-XAT series Ultra-Airtight IC Box. Also available in black prepainted steel; see section 8.6.

8.7 Black (Prepainted) Steel IC Boxes

Popular

For even greater heat dissipation, most Reduced Airflow/Chicago Plenum and Ultra-Airtight IC Boxes are also available in prepainted black steel. Other benefits include visual absorption, whereby the inside of the IC box becomes almost invisible - especially important for large and/or multi-lamp cutouts. See [black IC boxes](#) for more information. These IC boxes are very popular among high-end OEMs. Some who also emboss their name/logo on the plaster frames or other parts.

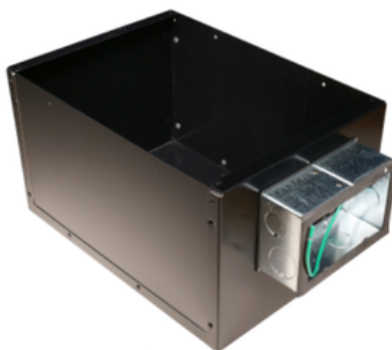

Fig. 60 1681BL-11 IC Box



Fig. 61 Embossed plaster frame

See section 8.3 for an IC Box Model Comparison table that conveniently illustrates all currently available standard options.

8.8 IC Boxes with Junction Box 70

IC Boxes are also available with a large gasketed junction box, measuring 7-7/8" x 4" x 2" deep, having an interior volume of approximately 70 cu. in. (as opposed to our IC Boxes with our standard gasketed junction box measuring 4-7/8" x 3-1/8" x 1-7/8" deep, containing an interior volume of approximately 27 cu. in.). Reasons for selecting an IC Box with the larger junction box are explained in section 7.4.2.



Fig. 62 1481-11 IC Box, with Junction Box 70
Available in Trapezoid IC Box

IC Box w/ J-Box 70 Part #2 ²	IC Box Part #1 ¹	Description	BOX (Dims. in inches)			Fits w/Plaster Frame Series
			Length	Width	Height	
1481-11 (AT)	1681-11 (AT)	Standard I.C. Box	11-3/4	8-1/2	6-3/4	1286-X
1484-11 (AT)	1684-11 (AT)	Large I.C. Box	14-7/8	12		1483-1-X
1482-11 (AT)	1682-11 (AT)	Large I.C. Box - Tall			8-1/2	1483-1-X

¹ Original IC Box, with smaller J-Box, please [click here](#) to read the related product bulletin. Requires Snap-on Inner J-Box Cover 1242-31 & Screw-on Outer J-Box Cover 1242-30.

² Requires Snap-on Inner J-Box Cover 1442-31 & Screw-on Outer J-Box Cover 1442-30.

Also available in Pre-Painted black; please [click here](#) to read the related product bulletin. Add “BL” after 148X, e.g., 1481BL-11; see [Black IC boxes](#). See section 8.3 for an IC Box Model Comparison table that conveniently illustrates all currently available standard options.

8.8.1 IC Boxes with Slim Junction Box

IC Boxes are also available with our “Slim” Gasketed Junction Box, measuring 5-7/8” x 2-1/8” tall x 1-7/8” deep, having an interior volume of approximately 21 cu. in. (as opposed to our IC Boxes with our standard gasketed junction box measuring 4-7/8” x 3-1/8” x 1-7/8” deep, containing an interior volume of approximately 27 cu. in.). The “Slim” also offers two potential significant benefits.

- 5-7/8” length allows for installation flexibility of long drivers, and,
- 2-1/8” cover height allows for withdrawal through small ceiling opening.



Fig. 63 #1775-11 Mini I.C.Box

Reasons for selecting an IC Box with the different junction box volumes are further explained in section 7.4.2. See section 8.3 for an IC Box Model Comparison table that conveniently illustrates all currently available standard options.

8.9 Gasketed Airtight Junction Box

Both the Reduced Airflow & Ultra-Airtight IC Boxes contain a gasketed junction box riveted to one end (available with three sizes of junction box). In order to maintain airflow restrictions, the knockouts do not contain screwdriver pry-out slots, and are pushed in, and then back slightly for two reasons; to maintain airflow restrictions as well as to pass the knockout force resistance test prescribed by UL1598, para. 16.13. Removing the desired knockouts is achieved by knocking them inward.

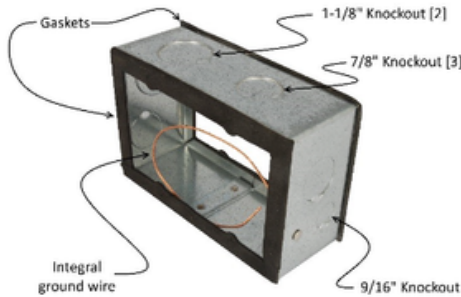

Fig. 64 Integral gasketed junction box used on Reduced Airflow & Ultra-Airtight IC Boxes

Also available separately in three sizes:

1781-92-1: 5-7/8" wide x 2-1/8" tall x 1-7/8" deep, 21 cu.in.

1281-92-1: 4-7/8" wide x 3-1/8" tall x 1-7/8" deep, 27 cu. in. (shown above)

1481-92-1: 7-7/8" wide x 4" tall x 2" deep, 70 cu. in.

Volume Expansion

To use these Extenders, like always, two #8-32 self-tapping screws are installed into the cover mounting holes (but only partially and without any cover in place).

A second identical JBox = our AT Extender Box*; is then joined by rotating it so the angled slots on the rear face engage under the heads of the partially installed screws. These screws may then be fully tightened, securing the AT Extender Box to the base J-Box;

*- item #:

- 1781-92-1: "Slim" gasketed junction box
- 1281-92-1: Regular sized gasketed junction box (shown above)
- 1481-92-1: Large gasketed junction box 70

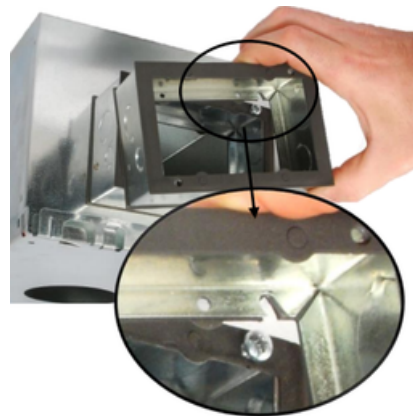

Fig. 65 Junction Box Volume Expansions

8.9.1 Junction Box Covers (Reduced Airflow & Ultra Airtight)

Outer Junction Box Cover

These outer junction box covers are installed using two or four 8-32 self-tapping screws;

1742-30: "Slim" size junction box outer cover

1242-30: Regular size junction box outer cover

1442-30: Large size junction box 70 outer cover



Fig. 66 Outer junction box covers #1742-30 (left), #1242-30 (middle) & 1442-30 (right)

Inner Junction Box Cover

The inner junction box covers 1742-31, 1242-31 and 1442-31 are snapped on against the receiving hole on the inside face of all Reduced Airflow and Ultra-airtight IC Boxes. Removal is achieved by raising the spring lever that comes riveted to this cover. Wire passage is permitted via the 9/16" wore hole that come standard in this cover. Other covers are available with different wire passage and/or driver mounting holes.



Fig. 67 Inner junction box flat cover #1742-31 (left), #1242-31 (middle) & 1442-31 (right)

Driver size mounting to the inner (exposed) face of inner junction box cover 1242-31 is limited in size due to the projecting spring lever. However, for its standard size Airtight Junction Box only (1281-92-1), Tripair offers its 1242-XXB-AT series of inner covers, which contain a projecting face. This allows larger drivers to be mounted, whose footprint may extend beyond that surface. See [Volume expansion](#) for examples.

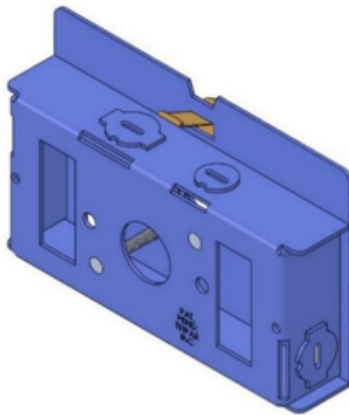

Fig. 68 Inner junction box 3D cover #1242-18B-AT
(Suitable for only Standard size Airtight Junction Box 1281-92-1)

9. Downlight Suspension for New Construction

Building codes require recessed downlights to be affixed or secured to the structure or mechanicals in the ceiling thus usually come with one or more means to suspend it from the ceiling prior to the ceiling being installed. The two most common ceiling suspension requirements are drywall which is typically screwed to wooden joists, and suspended ceilings which rest on T-Bar.



Fig. 69 Downlight suspension from wooden joists



Fig. 70 Downlight suspension from T-bar

9.1 Bar Hangers

The most common method of suspending downlight in either of the two above noted ceilings are using bar hangers, sometimes call hanger bars, nail bars or nailer bars. These typically consist of two metal bars that slide within two opposing sides of a plaster frame or Butterfly Brackets (see section 9.2.1) and should extend to fit between 16" spaced joists, and 24" spaced joists or T-Bar. Better bar hangers come with at least; integral nails for securing to wooden joists, and notches or other retention means for resting and locking on T-Bar. Two examples are shown below:

9.1.1 Bar Hangers (#1287)

Top seller

Tripair's 1287 bar hangers are extendible to fit between 16" spaced joists, and 24" spaced joists, but also have a formed toothed nail, notches for resting on and locking to T-Bar. These and other features are explained in [the New Product Bulletin that introduced them](#).



Fig. 71 Premium Bar Hanger #1287, two required per Plaster Frame Assembly

9.2.2 Commercial Bar Hangers (#1487)

Top seller

Commercial bar hangers usually contain the same features as a standard bar hanger, but are typically the most robust, having a much larger cross-section. They are often constructed from two members; a 1/2" x 1-1/2" C-Channel profile acting as the female, and a mating male profile. This assembly fits into receiving pockets in Butterfly Brackets (see section 9.2.1).

Tripair's 1487* L-Bars: Developed by Tripair, the L-Bars™* offer a superior and more robust solution, that some would refer to as "commercial bar hangers". These do not mount directly into the plaster frame, but rather into what are known as Butterfly Brackets, used when vertical adjustment is also desired (see section 9.2 Vertical Adjustment).

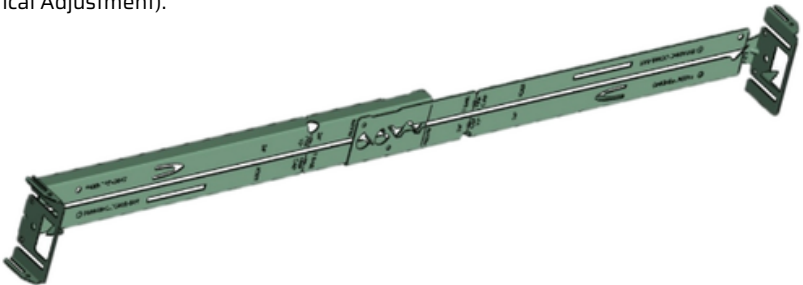

Fig. 72 Set of two L-Bars #1487, 4 required per Plaster Frame Assembly

Patented
TripairInc.com/PAT

Tripair's 1487* L-Bars™ form this 1/2" X 1-1/2" rigid C-Channel shape when assembled, and fit through the 1254 Butterfly Bracket, offering many more unique features making installation and adjustment easier and quicker, including;

- Two identical parts in all aspects, therefore interchangeable.
- Extendable to fit spacing from 12" spaced joists to 24" T-Bar
- Fastenerless extension locking - accessible from side or bottom
- Self-locking in Tripair's 1254 Butterfly Bracket
- Marking lines for 12", 16", & 24" joist spacing & 24" T-Bar allow for locking before installation
- 36"-48" extension with addition of 1-2 more identical & locking L-Bars
- Integral formed & barbed nail
- Tabs/slots for positioning, lateral adjustment, and removal from joists
- T-Bar slot and locking screw feature

See the [New Product Bulletin](#) that introduces them.



9.2 Vertical Adjustment

Overview

When bar hangers are mounted directly to, or passed through the plaster frame, no vertical adjustment is permitted.

It is often advantageous and sometimes necessary for the fixture to have an integral means of being vertically adjusted in order to permit the luminaire to rest at its intended position no matter what the type of ceiling construction. This can be particularly prevalent during extensive renovations within old commercial buildings, where builders and electricians must contend with the existing structure. The most common vertical adjustment practice is by incorporating what are known as "Butterfly Brackets", which slidably mount to opposing sides of the fixtures.

To offer vertical adjustment, brackets are attached to either the plaster frame or plaster ring. A straight bracket, such as Tripar's 1253 or 1253-4*, is riveted to two opposing sides of a plaster frame. An L-Bracket, such as Tripar's 1253-1 is riveted to two opposing surfaces of a plaster ring.

To this, a Butterfly Bracket is attached, most often with a carriage bolt and wing nut. A slot within either or both brackets permit vertical adjustment.



Fig. 73 Plaster frame with Straight Brackets #1253 or 1253-4* & Butterfly Brackets #1254



Fig. 74 Plaster Ring with L-Brackets #1253-1 & Butterfly Brackets #1254

*The overall height of Sliding Bracket 1253 is 4-3/4", whereas Sliding Bracket 1253-4 is 3-1/2"; this shorter bracket being ideally suited to maintain the 3-1/2" height of the Small Ultra Shallow IC Box series 1485-XX.

9.2.1 Butterfly Bracket

Better Butterfly brackets enable the downlight to be suspended by a variety of means, by passing through them; bar hangers, conduit, furring strip, or C-Channel. Tripar's 1254 Butterfly Bracket accepts these all as shown below.

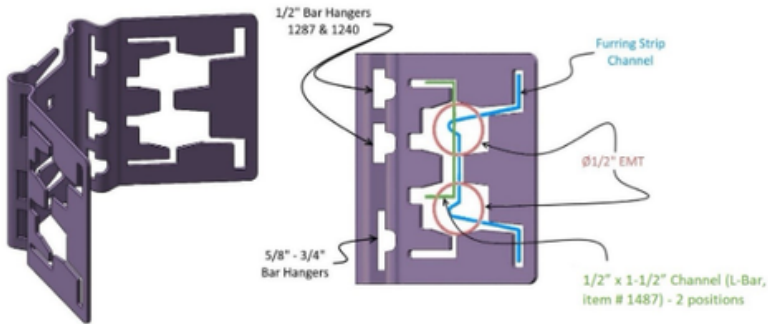

Fig. 75 #1254 Butterfly Bracket & End View showing compatibility with various suspension means

When Tripar's 1287 bar hangers are passed through either one of the two small bar hangers' slots, tightening of the wing nut locks both vertical movement relative to the Sliding Bracket, as well as lateral movement of the downlight relative to the bar hangers.

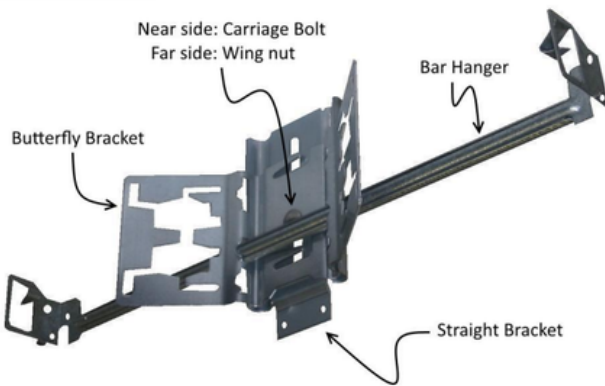

Fig.76 #1287 Bar Hanger installed in #1254 Butterfly Bracket #1253 (or 1253-4) Straight Bracket



Fig.77 #1487 L-Bars installed in #1254 Butterfly Bracket/#1253 (or 1253-4) Straight Bracket

[See 1487 L bar for more information and videos covering installation and overview.](#)

9.2.2 Caterpillar Bracket

If vertical adjustment is desired, but with no other means of suspending the downlight than using Tripar's 1287 bar hangers, then Tripar's 1054 Caterpillar Bracket may be used. These are the same as the Butterfly Bracket, except contain no wings, permitting support only using these bar hangers.

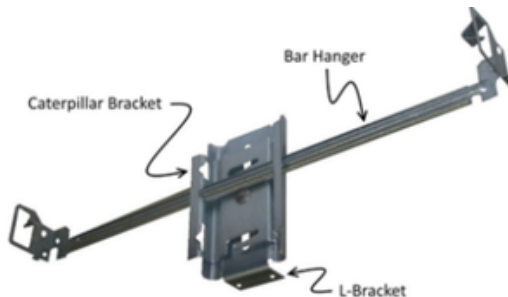

Fig.78 Bar Hanger installed in #1054 Caterpillar Bracket/#1253-1 L-Bracket

See the [New Product Bulletin that introduced these](#), which also offers a more comprehensive comparison between the two brackets.

9.3.3 Kits

A convenient variety of bar hanger & bracket kits are available (poly-bagged), permitting the OEM to drop these into their luminaire boxes as required; see [Tripar's support system kits](#).

10. Driver boxes

In some instances, an alternative to a junction box is a driver box, also referred to as a remote connection box. These can be desirable in a number of instances;

- When the driver is too large to fit on or within the fixture
- To power more than one fixture
- When the driver or luminaire produce excess heat

Driver Boxes are available in various sizes and are used to house a driver. They typically contain a mechanical means to secure the driver to the base of the driver box, a removable cover, and at least one hole or knockout for incoming line voltage (120 VAC), and at least one for the output of the driver to power the luminaire(s).

They may be installed remotely (e.g., in a wall with an access door), affixed to the plaster frame, or rest on the topside of the ceiling. Depending on the driver's power and proximity of downlights, they can be used to power more than one luminaire. Tripar offers several models of Driver Boxes.

10.1 The Universal Driver/Junction Box

This is the most innovative and flexible, offered in two sizes; the Small; measuring 2-3/8" wide x 1-5/8" high, and the Large; measuring 4" wide x 2" high. Each of these is available in lengths from 8" to 120", to meet wide-ranging lighting OEM requirements, and include a host of additional innovative features.

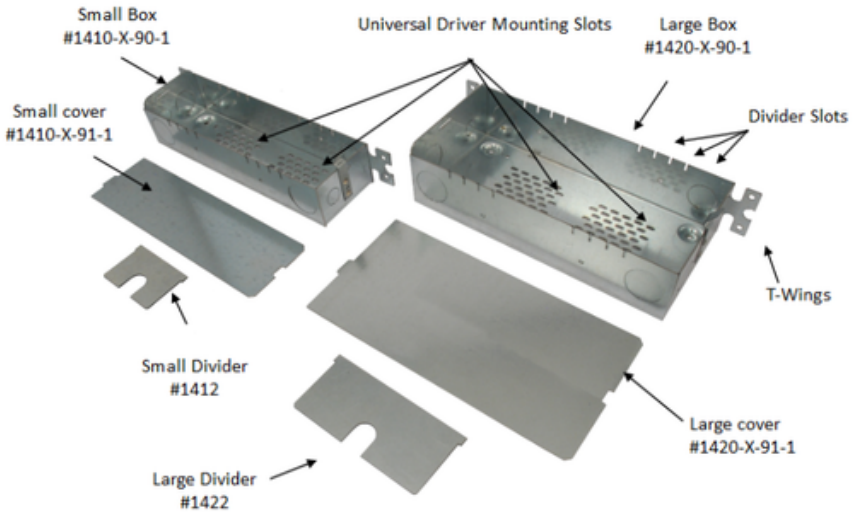

Dimensions	Item #	Description
2-3/8" Wide x 1-5/8" High	1410-X	Box & Cover Assembly, Small
	1410-X-90-1	Box, Small
	1410-X-91-1	Cover, Small
	1412 (Optional)	Divider, Small
4" Wide x 2" High	1420-X	Box & Cover Assembly, Large
	1420-X-90-1	Box, Large
	1420-X-91-1	Cover, Large
	1422 (Optional)	Divider, Large
Replace X with length required; E.g., 1410-9.25-90-1 for 9.25" long small box.		

The Universal driver/junction boxes contain the following additional features:

1. Universal driver mounting – array of slots¹, sized to accept # 8-32 x 1/4" long self-tapping screws (projecting feet on bottom conceal projecting mounting screws).
2. Drivers mount in full contact with base of box for optimal heat dissipation.
3. Multiple knockout hole sizes at each end: 9/16", 7/8" & 1-1/8".
4. Multiple mounting options:
 - Bottom & side # 8 screw holes for structure mounting.
 - To a variety of plaster frames for use as junction box using the side rivet holes; either directly or to Tripar's offset Z-Bracket.
 - T-Bar™ using the Tripar T-Wings™.
5. Ground wire hole at each end, sized to accept 1/8" rivet or # 8-32 self-tapping screw.
6. Matching length snap-on cover with Triparloc™ feature²
7. Snap-on covers can be customized to allow driver mounting.
8. Optional slide-in dividers for line & low voltage separation can be placed in four positions; 1-1/2", 2", 2-1/2" & 3" from each end.
9. Slide in divider contains protected wire passage slot³.
10. All components made of 0.05" thick galv steel to comply with UL1598.



¹ 7-9 rows of slots over a 2" span at each end to accommodate up to 4" driver length variation.

² Cover is intentionally convex so it flattens to the box upon assembly preventing any gaps. Install # 8-32 self-tapping screw in hole adjacent to free end of spring for tamper-proof assembly.

³ Metal around slot is rolled over to provide integral strain relief. Dividers also have light interference fit with box to prevent accidental loss, and any noise from vibration.



Fig.79 Mounted to Plaster frame with Driver installed to cover



Fig.80 Mounted to T-Bar using the integral T-Wings

See [universal driver boxes](#)

10.2 Traditional Driver Boxes

Though less flexible, fixed length driver boxes are also an option, with mounting holes located to mount a single specific driver. Below are examples of several such driver boxes offered by Tripar:

- 1379: 12-1/2" long x 3" wide x 1-15/16" tall.
- 1381: 9" long x 1-3/4" wide x 1" tall
- 1383: 11-1/2" long x 1-7/8" wide x 1-3/4" tall.
- 1385: 9-1/2" long x 1-7/8" wide x 1-1/2" tall
- 1387-10: 4-1/2" long x 1-7/8" wide x 1-1/2" tall.
- 1389: 6" long x 1-7/8" wide x 1-1/2" tall

You can view all [our Driver boxes here](#).

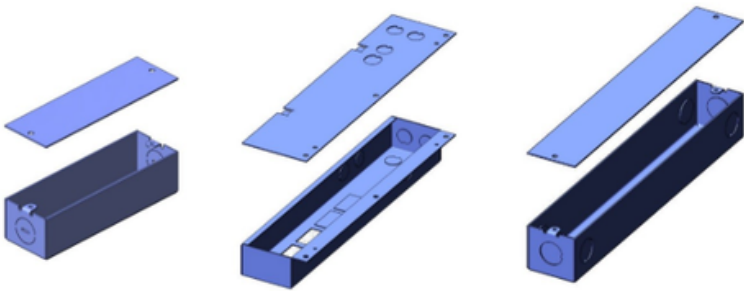

Fig.81 Fixed length Driver Box & Cover

Tripar can also manufacture similar driver boxes in almost any size.



Thanks for reading

Hi friend,

Thanks for reading. We hope you benefitted from this guide – covering the mechanical aspects and requirements for Recessed Lighting in North America – and that you are now more knowledgeable on the subject.

If you have any specific requirements or do not see a readily available solution, please ask us. We are constantly modifying existing components to suit our client's needs and design requirements.

Lastly, if you have any feedback or questions or need help, reach out anytime at sales@triparinc.com. You're in good hands.

Be good,

Lloyd Sevac
President, Tripar Inc.
Celebrating *75 years in business*

PS. Let's connect on LinkedIn

Recessed Lighting

Designed to UL1598 specifications



Bringing the magic of metal to light

Tripair is the **“gold standard”** for architectural and commercial lighting OEMs who demand quality, perfection and precision every time.

We are constantly evolving to stay ahead of market trends to ensure we always offer the best products for the OEM lighting market (and have over 9 patents.)

We offer a full range of metal parts for the lighting industry:

- ✓ IC Boxes
- ✓ Junction/Driver box
- ✓ Retrofit components
- ✓ Plaster Frames
- ✓ Accessories
- ✓ Light fixtures & parts

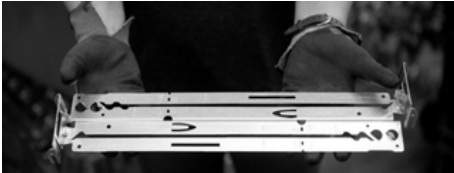

Metal Stamping

- ✓ 100 presses
- ✓ Progressive stamping
- ✓ 1600+ dies
- ✓ Drawing & deep drawing
- ✓ Embossing
- ✓ CNC milling



CNC Fabrication

- ✓ 2 CNC laser
- ✓ CNC Laser/Punch
- ✓ 7 Press brake
- ✓ 3 CNC Punch press
- ✓ Spot Welding
- ✓ Metal assembly

The Tripair Advantage

We work with every OEM client to achieve innovative products at the lowest possible cost. In fact, Tripair is one of the rare few companies that offers *“hybrid manufacturing”*: using CNC or metal stamping or a combination of both (whatever saves you the most money.) We can produce a wide range of metal parts for you with quantities from prototypes to millions of units annually. We handle it all: design, engineering and fabrication.

Proudly serving 350+ clients in the US, Canada, Europe and Asia



HVAC



Warehouse Racking



Appliances/Furniture



Aerospace



T: 514 648 7471 | Toll-Free: 1800 361 0938 | TripairInc.com
9750 Boul. Maurice-Duplessis, Montreal, QC H1C 1G1

48-hour lead time

 Clickable product links

Request your free sample

To get a free sample of any of our stocked items, please contact lighting@triparinc.com.

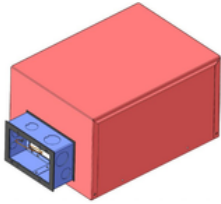

IC boxes

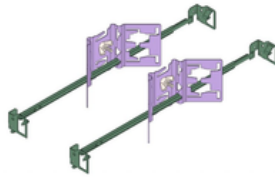

Support system kit

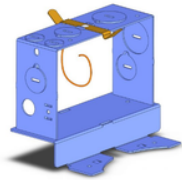

Junction boxes

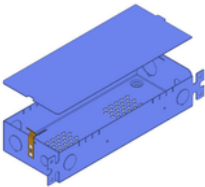

Driver boxes



Airtight covers

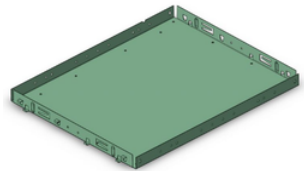

Plaster frames

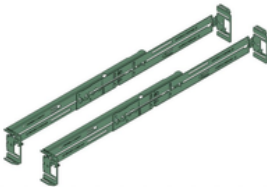

Commercial L-Bars™

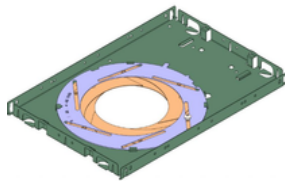



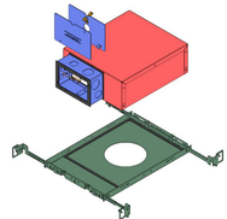



The Shutter™ p-frames

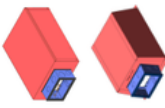
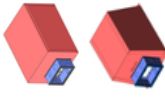

Assemblies

For a complete list of our products, visit our [online catalogue](#).

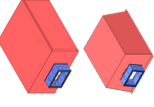
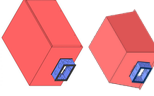
Appendix 1: IC Box Comparison Table

IC BOXES	"MINI" 1775 series	"ULTRA-SHALLOW" 1485 series	"STD. SHALLOW" 1685 series & 1785 Trapezoidal series	"STANDARD" 1681 series & 1781 Trapezoidal series	"LARGE SHALLOW" 1684-12 series	"LARGE STD." 1684-11 series	"LARGE TALL" 1682-11 series	"LARGE X-TALL" 1682-21 series
								
Height	2-1/4"	3-1/2"	4-3/4"	6-3/4"	5-1/8"	6-3/4"	8-1/2"	11-1/4"
Size (W x L)	8-1/2" x 9-5/8"	8-1/2" x 9-5/8"	8-1/2" x 11-3/4" 8-1/2" x 10-1/2"	8-1/2" x 11-3/4" 8-1/2" x 10-1/2"	12" x 14-3/4"			
Std. J-Box 27 cu.in Galvanized	n/a	1485-11 (AT) 1485BL-11 (AT) *	1685-11(AT) 1685BL-11(AT) * 1785-11* 1785BL-11*	1681-11(AT) 1681BL-11(AT) * 1781-11* 1781BL-11*	1684-12(AT) 1684BL-12(AT) *	1684-11(AT) 1684BL-11(AT) * 1784-11* 1784BL-11*	1682-11(AT) 1782-11* 1782BL-11*	1682-21(AT) 1682BL-21(AT) *
Large J-Box 70 cu.in Galvanized	n/a	n/a	1481-11(AT) 1481BL-11(AT) *	n/a	n/a	1484-11(AT) 1484BL-11(AT) *	1482-11(AT) 1482BL-11(AT) *	1482BL-21(AT) *
Slim J-Box 20 cu.in Galvanized	1775-11(AT) 1775BL-11(AT) *	Standard on the 1775-11(AT) Mini I.C.Box, available on all other I.C. Box sizes upon request		Standard on the 1775-11(AT) Mini I.C.Box, available on all other I.C. Box sizes upon request				
Plasterframe	1286 series		1486 series					

This is not the end but the beginning of:

- ... lighting magic
- ... lighting excellence
- ... lighting perfection
- ... lighting mastery
- ... lighting wow

Together we bring the magic of metal to light.

